

# ELECTRIC LINEAR ACTUATOR SOLUTIONS

FOR LIGHTWEIGHT AND  
HEAVY DUTY APPLICATIONS

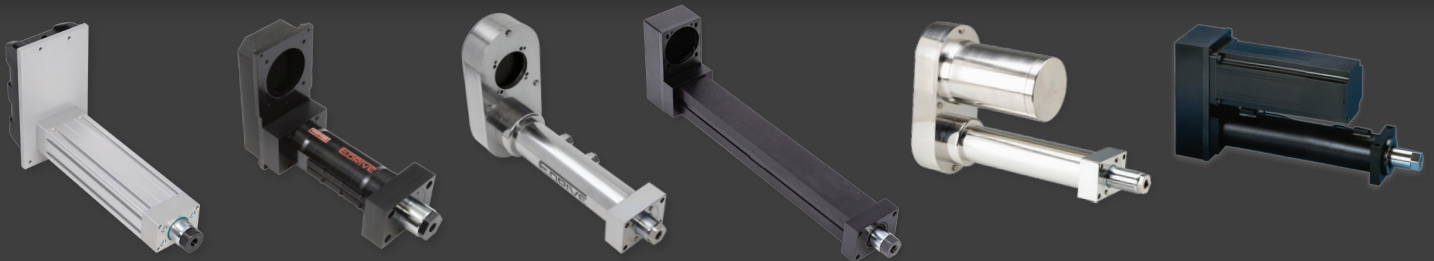

SERIES	UA				LS				VT /VP				SS454		HD /SP										SD			
	UA2	LS204	LS209	LS305	LS310	LS320	VT204 VP204	VT209 VP209	VT305 VP305	VT310 VP310	VT320 VP320	SS454	SS454	HD201 SP201	HD302 SP302	HD304 SP304	HD404 SP404	HD406 SP406	HD508 SP508	HD516 SP516	HD618 SP618	HD625 SP625	HD740	SD980	SD948	SD966	SD999	
VELOCITY																												
63 in/sec max	50																											
40 in/sec max																												
20 in/sec max																												
18 in/sec max																												
16 in/sec max																												
14 in/sec max																												
12 in/sec max																												
10 in/sec max																												
8 in/sec max																												
STROKE																												
60 in																												
54 in																												
48 in																												
42 in																												
36 in																												
30 in																												
24 in																												
18 in																												
12 in																												
6 in																												
THRUST																												
100,000 lbs max																												
66,000 lbs max																												
48,000 lbs max																												
40,000 lbs max																												
30,000 lbs max																												
25,000 lbs max																												
18,000 lbs max																												
16,000 lbs max																												
8,000 lbs max																												
6,000 lbs max																												
4,000 lbs max																												
2,000 lbs max																												
1,000 lbs max																												
500 lbs max																												

NOTE: Stroke length may affect maximum velocity. Contact EDrive Actuators for details.

# TABLE OF CONTENTS

Products ..... 5

Application Guide Worksheet ..... 8

Universal Actuator UA™ ..... 9

Tac VT™ Actuator ..... 14

Tac VP™ Actuator ..... 20

Tac LS™ Actuator ..... 26

Eliminator HD™ Actuator ..... 32

Eliminator HDL™ Actuator ..... 38

Eliminator SP™ Actuator ..... 44

Eliminator SPL™ Actuator ..... 50

Eliminator SS™ Actuator ..... 56

Eliminator SD™ Actuator ..... 62

Glossary ..... 68

Technical FAQ ..... 70

How to Select an Actuator ..... 72

Calculations ..... 73

Wiring Diagrams ..... 74



# Electric Linear Actuators

## FOR TOUGH, INDUSTRIAL AUTOMATION APPLICATIONS

EDrive Actuators, an exclusive brand of Joyce/Dayton, manufactures electric linear actuators for tough, industrial automation applications. Our products are used in a wide variety of industry applications where conservative design, rugged construction, long life, and high precision are required and valued, more specifically, as replacement for older power solutions like hydraulic and pneumatic linear actuators. The demand for electric linear actuators is growing among machine builders who want to improve their performance, reliability, and sustainability. Electric linear actuators provide faster speeds, longer life, and cleaner operation when compared to other types of linear motion systems.

### Benefits of Electric Actuation:

- Cleaner, quieter, and more energy efficient
- Improved performance
- Less maintenance required
- More accuracy and repeatability
- More flexibility and scalability
- Higher speed and force
- Higher system stiffness
- Lower operating costs

**EDrive Actuators, an industry pioneer since 1980 and now exclusive to Joyce/Dayton Corp., delivers precision electromechanical motion.**

Our customers benefit from both standard products and customized designs, backed by Joyce/Dayton's unparalleled expertise since 1873. Get tailored, high-quality electric actuator solutions with U.S. based support.



### Industries Served:

- Agriculture
- Automotive & Transportation
- Defense
- Food & Beverage
- Forestry & Lumber
- Material Handling & Packaging
- Motion Simulators & Entertainment
- And More

# PRODUCTS

Our products are used in a wide variety of industry applications where conservative design, rugged construction, long life, and high precision are required and valued.



## UA Series Actuators

The compact EDRIIVE UA actuators feature an aluminum extrusion cylinder and chrome pistons. They are designed to be easily incorporated into automation applications.

## Tac Series Actuators

EDRIIVE Tac Series actuators provide high quality rugged and durable linear motion for both low and high force applications. Using aluminum bodies with steel components, these more compact sized actuators are a good fit in most linear motion industrial applications.

## Eliminator Series Actuators

EDRIIVE Eliminator Series actuators provide strong, durable, and precise linear motion for industrial automation. They were designed to replace hydraulic actuators and thus “eliminate” many associated concerns, such as noise and fluid leakage.

## IP69K STAINLESS STEEL

EDRIIVE IP69K actuators are strong, durable, and precise linear actuators for high-end applications in areas requiring frequent exposure to high-pressure, high-temperature washdown. Exterior surfaces are constructed of 316 Stainless Steel and are ideally suited for severe environments and caustic wash-down conditions.

## INTERNAL LOAD CELLS

EDRIIVE offers Heavy-Duty linear actuators with Integrated Load Cells which feature bi-directional force feedback. These actuators provide continuous, accurate measurement of applied loads and forces and offer an economical solution for precise applications. Internal Load Cells are available on Eliminator Series actuators.

# Consistent Success IN THE TOUGHEST APPLICATIONS

**EDrive linear actuators** have shown consistent success in the toughest applications, e.g., high loads, high speeds, high precision, and extreme durability. Precision ball screw systems, tailored for maximum life, load and speed, provide the motion while fully enclosed, thus eliminating contamination-related failures. A long bronze nose bearing provides support for the extended piston. Rugged bronze keys in opposing steel slots provide anti-rotation and counter the tangential forces created during high speed, high frequency, and high load operation.

## Eliminator Series Actuator

### EDrive's Eliminator Series Features:

- Capacities up to 100,000 lbs
- Steel or 316 stainless steel
- Standard stroke lengths up to 48"
- Velocity up to 63 in/sec
- Internal Load Cell option

Standard Configurations Include Parallel Offset (1:1 or 2:1) and Inline

Designed to Mount Any Motor

Adjustable Limit Switches Available

Rugged Piston Anti-Rotation Features a Pair of Opposing Keys

Internal Bumper Helps Prevent Jamming at Both Ends of Travel

Long Sleeve Bearing Guides and Supports the Piston

High Capacity Precision Ball Screw and Support Bearing System

Re-Grease Provision from Either Side

High Strength Heavy Wall Steel Cylinder Provides Rigidity, Stability and Protection

Rod Wiper Seal Protects the Internal Components

Chrome Plated, Heavy Wall Steel Piston Provides Rigidity and a Hard Chrome Plate

While other actuator designs force a particular motor decision, EDrive's linear actuators are designed to suit virtually any motor, gear box, or gearhead the customer chooses to use. Inline as well as parallel offset configurations are standard with 1:1 and 2:1 synchronous gearbelt ratios available.

Products available in Parallel Offset and Inline configurations.

## Tac Series Actuator

### EDrive's Tac Series Features:

- Capacities up to 2,000 lbs
- Aluminum or 316 stainless steel
- Standard stroke lengths up to 60"
- Velocity up to 40 in/sec

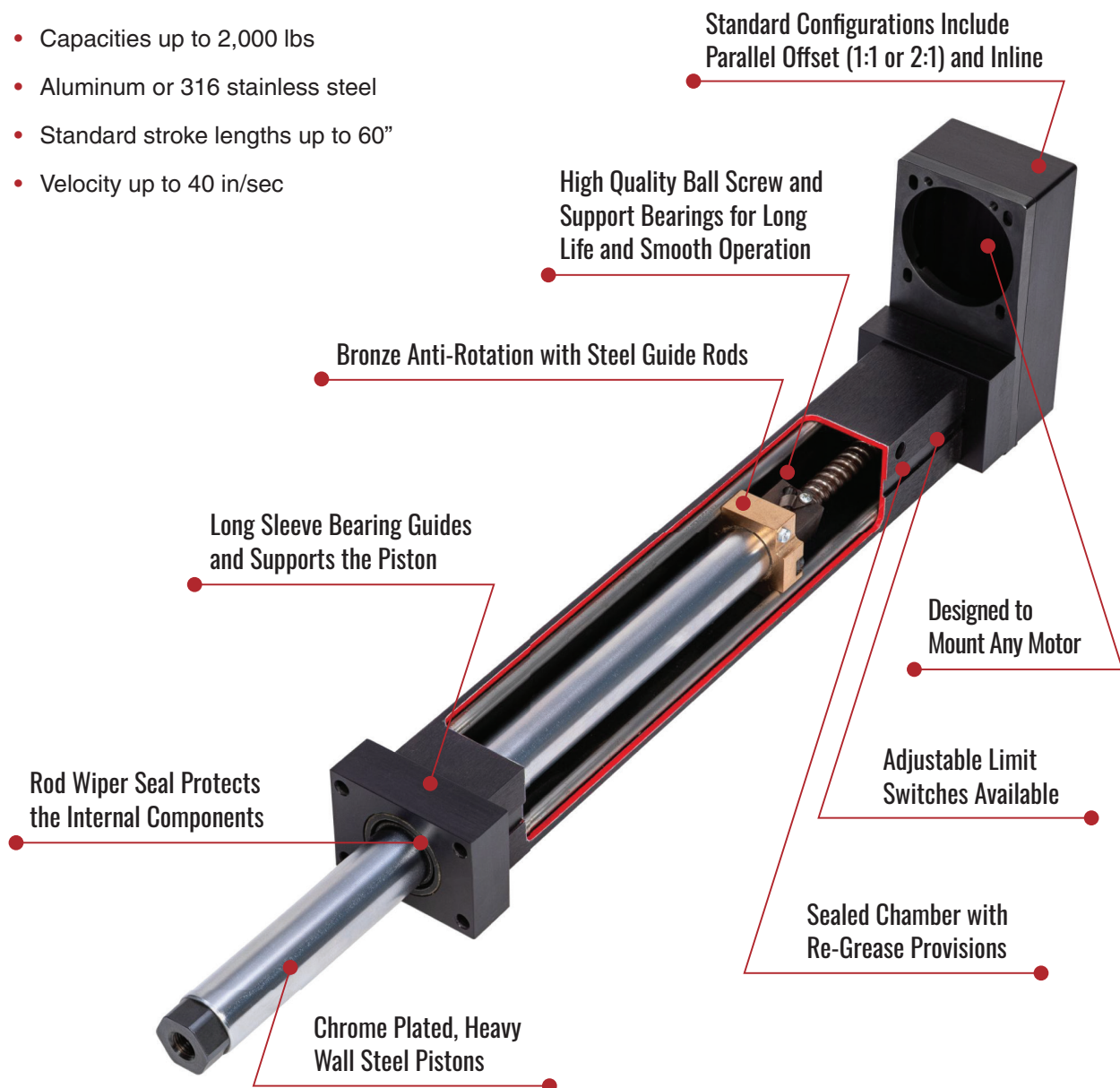

# APPLICATION GUIDE WORKSHEET

Name \_\_\_\_\_ Position \_\_\_\_\_

Company \_\_\_\_\_ Industry \_\_\_\_\_

Address \_\_\_\_\_

Phone \_\_\_\_\_ Email \_\_\_\_\_

## ACTUATOR ORIENTATION

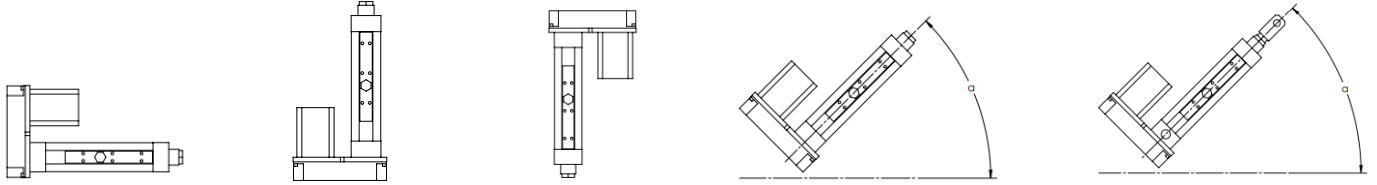

Horizontal       Vertical UP       Vertical DOWN       Incline angle,  $\alpha$  \_\_\_\_\_       Pivoting angle,  $\alpha$  \_\_\_\_\_ - \_\_\_\_\_

## ACTUATOR REQUIREMENTS

Stroke Length \_\_\_\_\_  in  mm      Repeatability \_\_\_\_\_  in  mm

Run Time  
 \_\_\_\_\_ Cycles per Min  
 \_\_\_\_\_ Hours per Day  
 \_\_\_\_\_ Days per Week

## MOTOR REQUIREMENTS

Motor Brake   
 Motor Code \_\_\_\_\_

## MOTION PROFILE

### Extend

Move Distance \_\_\_\_\_  in  mm  
 Move Time \_\_\_\_\_ seconds  
 Max. Speed \_\_\_\_\_  in/sec  mm/sec  
 Dwell Time after Move \_\_\_\_\_ seconds  
 Max Force \_\_\_\_\_  lbf  N

### Retract

Move Distance \_\_\_\_\_  in  mm  
 Move Time \_\_\_\_\_ seconds  
 Max. Speed \_\_\_\_\_  in/sec  mm/sec  
 Dwell Time after Move \_\_\_\_\_ seconds  
 Max Force \_\_\_\_\_  lbf  N

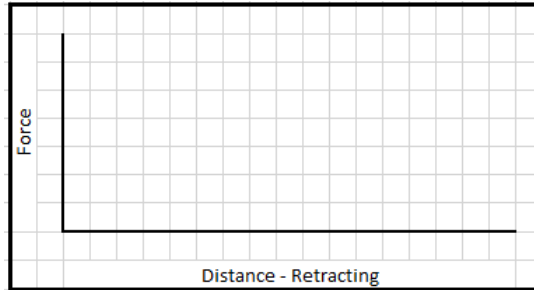
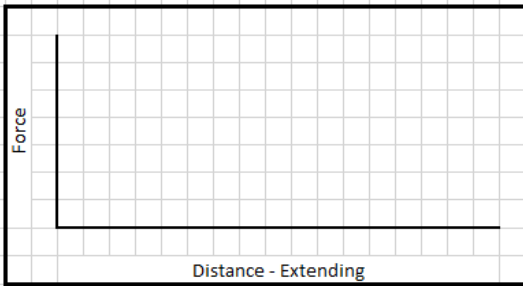

## ENVIRONMENTAL CONDITIONS

Temperature Range \_\_\_\_\_ to \_\_\_\_\_ °F °C

- Dust
- Sand
- Oil
- Water
- Outdoor
- Washdown
- Other \_\_\_\_\_
- Caustic (specify) \_\_\_\_\_

## OTHER ACTUATOR OPTIONS

- Parallel Offset Motor Mounting
- In-Line Motor Mounting
- Integrated Load Cell
- Internal Anti-Rotation
- Food Grade Grease
- Limit Switches
- Protective Boot
- Zero Backlash
- Stainless Steel

## ADDITIONAL INFORMATION

\_\_\_\_\_

\_\_\_\_\_

\_\_\_\_\_

# Universal Actuator UA™

## COST EFFECTIVE, GENERAL PURPOSE AUTOMATION SOLUTION

EDrive's Universal Actuator UA series is designed to be easily incorporated into automation applications. These compact actuators feature an aluminum extrusion cylinder designed with industry-standard T-slots for quick mounting. Chrome piston with anti-rotation is standard and available in lengths up to 24 inches and speeds up to 50 in/sec. Quickly position limit switches along the cylinder. Ideal for a variety of industries and applications including Industrial Automation, Robotics, Packaging, Food, and Beverage.



### Key Features:

- Rated thrust up to 500 lbf
- Velocity up to 50 in/sec
- Designed with T-slot bracketing for quick mounting
- Sealed from contamination (IP54)
- Adjustable limit switches available
- Piston with internal anti-rotation

### *Ideal for a Variety of Applications Including:*

- Gating/Sorting/Diverting
- Assembly, Pick & Place
- Aligning, Product Changeover
- Conveyors, Fillers
- Pneumatic Replacement
- And More

# SPECIFICATION CHART FOR THE UNIVERSAL ACTUATOR UA

Model Number	Screw Code	Rated Thrust	Max. Velocity	Max. Stroke	Frame Size	Screw Lead	Backlash Max.	Max. Screw Speed	Max. Torque At Screw	Dynamic Capacity Per Million Revs	Dynamic Capacity Per Million Inches
		lbf	in/s	in	in	in	in	RPM	in-lb	lbf	lbf
UA2	AB2	500	50	24	2	0.5	0.010	6,000	44	1,002	738
UA2	AB5	500	16	24	2	0.2	0.010	4,800	18	1,221	714

Model Number	Max. Motor Or Gearhead Pilot Supported	Inertia 1:1 Zero Stroke	Inertia 1:1 Per Inch Of Stroke	Inertia 2:1 Zero Stroke	Inertia 2:1 Per Inch Of Stroke	Inertia Inline Zero Stroke	Inertia Inline Per Inch Of Stroke	Weight "P1/P2" Mount Zero Stroke	Weight "L0" Mount Zero Stroke	Weight Per Inch Of Stroke
	in	lb-in <sup>2</sup>	lb-in <sup>2</sup>	lb-in <sup>2</sup>	lb-in <sup>2</sup>	lb-in <sup>2</sup>	lb-in <sup>2</sup>	lb	lb	lb
UA2	3.74	0.4	0.0016	0.21	0.0004	0.13	0.0016	5.75	5.5	0.5
UA2	3.74	0.41	0.0031	0.21	0.0008	0.13	0.0031	5.75	5.5	0.5

## DATA CURVES FOR THE UNIVERSAL ACTUATOR UA

### Dynamic Capacity: Life Vs. Load

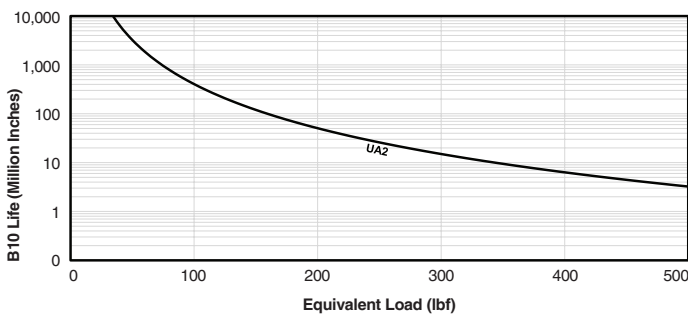

### Force Vs. Speed

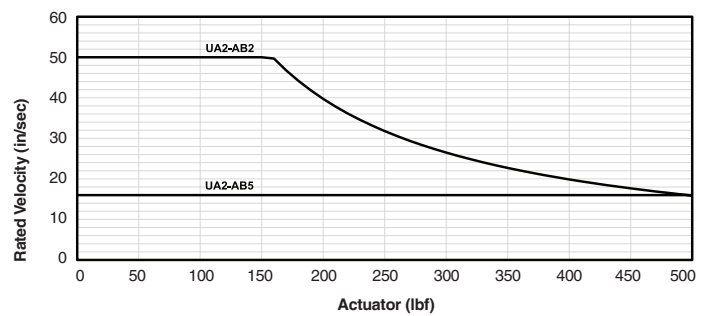

### Speed Vs. Stroke

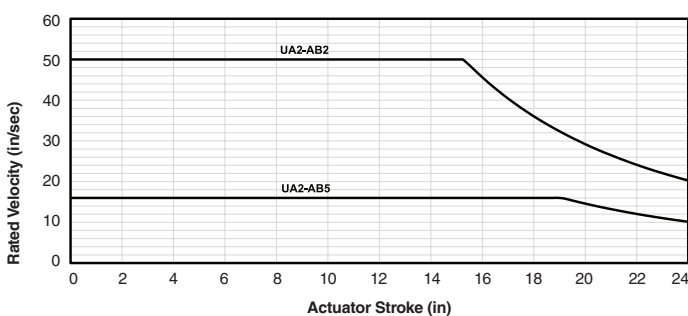

# ORDERING GUIDE FOR THE UNIVERSAL ACTUATOR UA

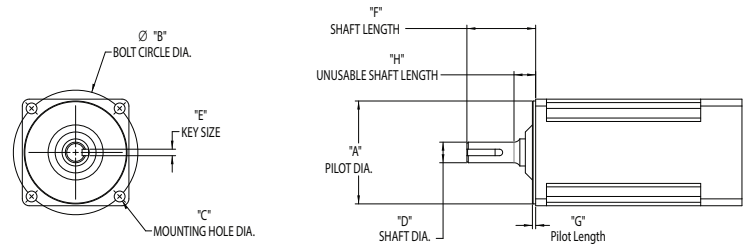

## Ordering Information

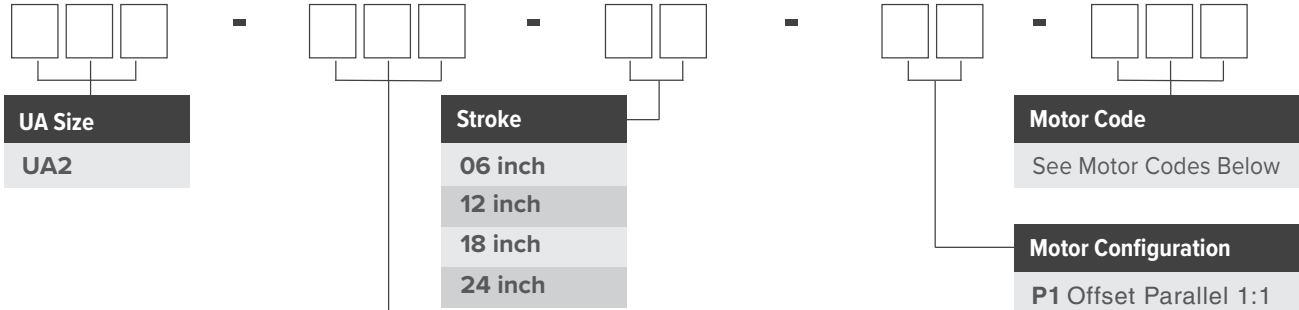

Screw Code	Dia.	Lead	Type	Lead Accuracy
AB2	1/2"	0.5"	Ball Screw	0.003 in/ft
AB5	5/8"	0.2"	Ball Screw	0.003 in/ft

## MOTOR CODES

Motor Code	"A" Pilot Diameter	"B" Bolt Circle Diameter	"C" Mounting Hole Diameter		"D" Shaft Diameter (1)	"E" Key Size	"F" Shaft Length		"G" Pilot Length	"H" Unusable Shaft Length
			Min	Max			Min	Max		
GDH	1.500 in	2.625 in	0.169 in	0.228 in	1/4 in	N/A	0.781 in	0.844 in	0.20 in	0.20 in
PTD	1.500 in	2.625 in	0.169 in	0.228 in	1/2 in	1/8 in	1.25 in	1.625 in	0.20 in	0.20 in
DBC	2.875 in	3.875 in	0.209 in	0.248 in	1/2 in	1/8 in	1.188 in	1.575 in	0.20 in	0.375 in
PBD	2.875 in	3.875 in	0.209 in	0.248 in	1/2 in	5 mm	1.188 in	1.575 in	0.20 in	0.375 in
DCB	2.875 in	3.875 in	0.209 in	0.248 in	14 mm	5 mm	1.188 in	1.575 in	0.20 in	0.375 in
AGP	2.875 in	3.875 in	0.209 in	0.248 in	5/8 in	3/16 in	1.188 in	1.575 in	0.20 in	0.375 in
MPC	40 mm	63 mm	5.3 mm	6.3 mm	9 mm	3 mm	19 mm	31 mm	4 mm	4 mm
HCM	40 mm	63 mm	4.3 mm	5.3 mm	9 mm	3 mm	19 mm	31 mm	4 mm	4 mm
THP	50 mm	70 mm	4.3 mm	6 mm	8 mm	N/A	25 mm	31 mm	5 mm	5 mm
AMH	50 mm	70 mm	4.3 mm	6 mm	11 mm	4 mm	25 mm	31 mm	5 mm	5 mm
PCA	50 mm	70 mm	4.3 mm	6 mm	12 mm	4 mm	25 mm	31 mm	5 mm	5 mm
MCB	50 mm	70 mm	4.3 mm	6 mm	14 mm	5 mm	25 mm	31 mm	5 mm	5 mm
CMD	50 mm	70 mm	4.3 mm	6 mm	16 mm	5 mm	35 mm	41 mm	5 mm	5 mm
BDG	50 mm	95 mm	6.3 mm	7.3 mm	14 mm	5 mm	25 mm	31 mm	5 mm	5 mm
AHB	60 mm	75 mm	5.3 mm	6.5 mm	11 mm	4 mm	22 mm	31 mm	4 mm	4 mm
MBG	60 mm	75 mm	5.3 mm	6.5 mm	14 mm	5 mm	22 mm	31 mm	4 mm	4 mm
ADB	70 mm	90 mm	4.3 mm	6 mm	19 mm	6 mm	34 mm	41 mm	4 mm	4 mm
HPM	70 mm	90 mm	6.3 mm	7.2 mm	19 mm	6 mm	34 mm	41 mm	4 mm	4 mm
GTD	80 mm	5.50 in	8.3 mm	10.3 mm	14 mm	5 mm	25 mm	31 mm	5 mm	5 mm
CGM	80 mm	100 mm	6.3 mm	7.3 mm	16 mm	5 mm	35 mm	41 mm	9 mm	15 mm
PBT	80 mm	100 mm	6.3 mm	7.3 mm	14 mm	5 mm	30 mm	37 mm	9 mm	15 mm
TGA	80 mm	100 mm	6.3 mm	7.3 mm	19 mm	6 mm	34 mm	40 mm	9 mm	15 mm
TMD	80 mm	100 mm	6.3 mm	7.3 mm	19 mm	6 mm	40 mm	46 mm	9 mm	10 mm
PGH	80 mm	100 mm	6.3 mm	7.3 mm	22 mm	6 mm	42 mm	48 mm	9 mm	15 mm
HGM	95 mm	115 mm	8.3 mm	10.3 mm	19 mm	6 mm	35 mm	41 mm	9 mm	15 mm
PTB	95 mm	115 mm	8.3 mm	10.3 mm	19 mm	6 mm	52 mm	58 mm	9 mm	15 mm

(1) Max. Shaft for 2:1 is 16 mm (0.63 in)

## ACCESSORIES

Part Number	Description	Part Number	Description	Part Number	Description
D06-UAS	Reed Switch NO	RC-UA2	Rear Clevis	SRE-UA2	Spherical Rod Eye
T06-UAS	Reed Switch NC	FF-UA2	Front Flange Plate	MTE-UA2	Male Thread End
G06-UAS	Sinking Switch NO (NPN)	TB-UA2	Trunnion Brackets (Pair)	FRE-UA2	Female Eye
J06-UAS	Sinking Switch NC (NPN)	CB-UA2	Clevis Bracket	SAC-UA2	Self Aligning Coupler
K06-UAS	Sourcing Switch NO (PNP)	EB-UA2	Eye Bracket	CRE-UA2	Clevis Rod End
Q06-UAS	Sourcing Switch NC (PNP)	CP-UA2	Clevis Pin	ABC-UA2	Aluminum Belt Cover
		1/4-UAN	1/4-20 T-Nut		

Accessories sold separately

sales@joycedayton.com | +1 (937) 294-6261

# DIMENSIONED DRAWINGS FOR THE UNIVERSAL ACTUATOR UA

Dimensions are in inches and are subject to change without notice.

## Parallel Offset Configuration

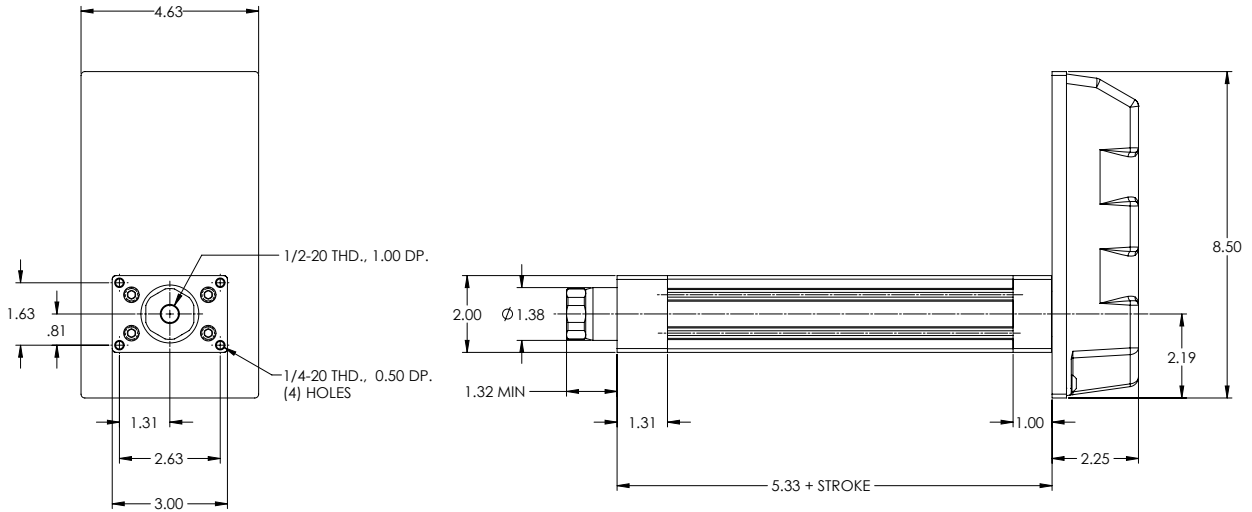

## Inline Configuration

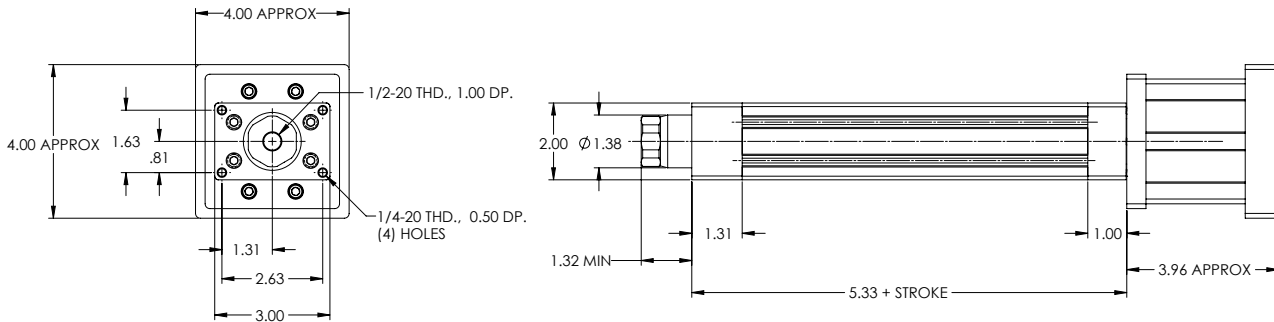

## UA Mounting Accessories

### Rear Clevis

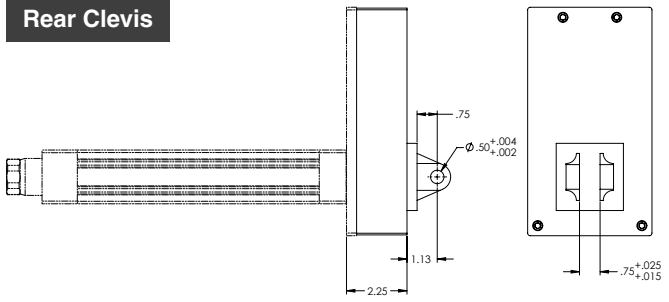

### Front Flange

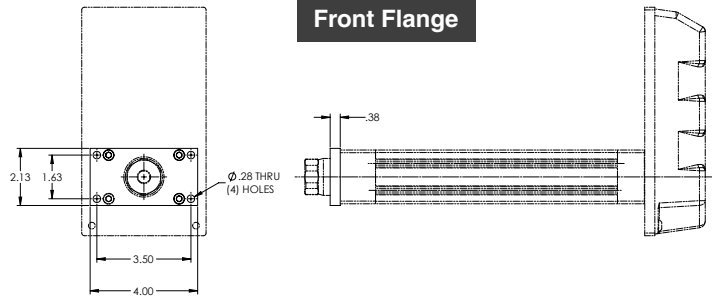

### Trunnion Brackets

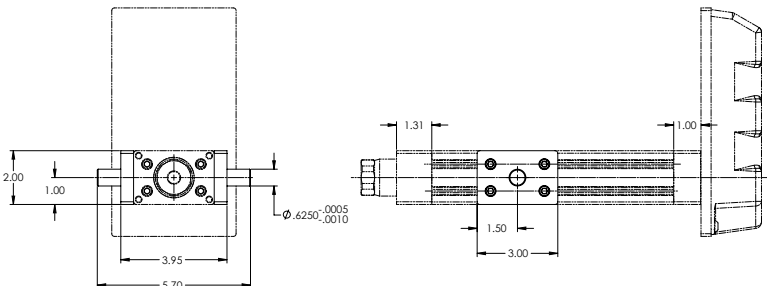

# DIMENSIONED DRAWINGS FOR THE UNIVERSAL ACTUATOR UA

Dimensions are in inches and are subject to change without notice.

## Rod End Accessories

### Male Thread

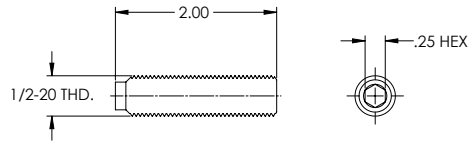

### Self-Aligning Coupler *Includes Male Thread*

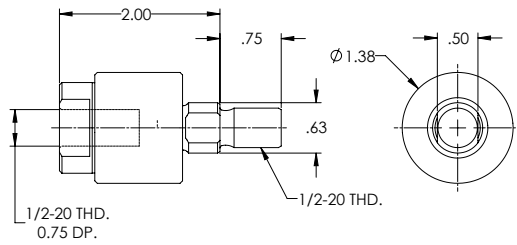

### Clevis Rod End *Includes Male Thread and Jam Nut*

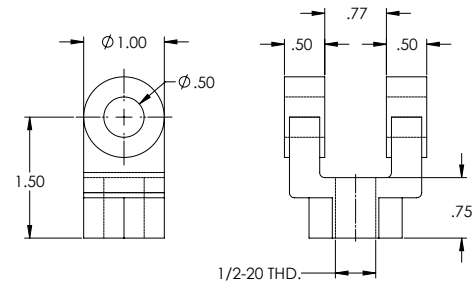

### Spherical Rod Eye

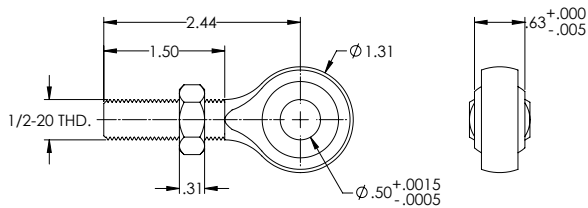

### Female Eye *Includes Male Thread and Jam Nut*

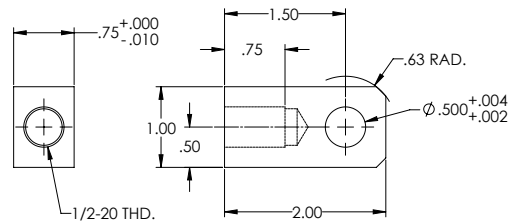

# Tac VT™ Actuator

## COST EFFECTIVE, HIGH QUALITY, HIGH SPEED, HIGH FORCE

The Tac VT ball screw linear actuator series was developed to meet higher thrust load requirements at faster velocities with high quality and rugged durability. Using an aluminum body with steel components, chrome plated heavy wall steel piston, and steel/bronze anti-rotation, this linear actuator ensures rigid alignment.



### *Ideal for a Variety of Applications Including:*

- Damper Valve Control
- Motion Simulators
- Conveying / Diverting
- Material Handling
- Pneumatic Replacement
- And More

### **Key Features:**

- Developed for higher thrust load requirements and faster velocities
- Compact actuator with thrust up to 2,000 lbf
- Velocity up to 40 in/sec, stroke up to 24 inches
- Sealed chamber design with purge provisions to meet IP54
- 0.003 in/ft standard lead accuracy
- Standard backlash is 0.004 in maximum

# SPECIFICATION CHART FOR THE TAC VT ACTUATOR

Model Number	Thrust Load Rated	Linear Velocity Max. <sup>1</sup>	Travel Length Max. <sup>2</sup>	Frame Size	Lead	Ball Screw Diameter	Ball Screw Max. <sup>1</sup>	Torque @ Ball Screw Max.	Dynamic Capacity Per Million Revs	Dynamic Capacity Per Million Inches	Motor Gearhead Frame Supported Max. <sup>2</sup>
	lbr	in/s	in	in	in	in	RPM	in-lb	lbr	lbr	in
VT204	400	16	24	2.25	0.50	0.50	1,920	35	1,070	850	3.5
VT209	900	9	24	2.25	0.20	0.63	2,700	32	1,410	825	3.5
VT305	500	40	24	3.25	1.00	1.00	2,400	88	2,300	2,300	4.5
VT310	1,000	20	24	3.25	0.50	1.00	2,400	88	5,350	4,250	4.5
VT320	2,000	10	24	3.25	0.25	1.00	2,400	88	5,475	3,450	4.5

Model Number	Inertia 1:1 Zero Stroke <sup>3</sup>	Inertia 1:1 Per Inch of Stroke <sup>3</sup>	Inertia 2:1 Zero Stroke <sup>3</sup>	Inertia 2:1 Per Inch of Stroke <sup>3</sup>	Inertia Inline Zero Stroke <sup>3</sup>	Inertia Inline Per Inch of Stroke <sup>3</sup>	Unit Weight "U" Motor Mount <sup>4</sup>	Unit Weight "L" Motor Mount <sup>4</sup>	Weight Per Inch of Stroke <sup>4</sup>
	lb-in <sup>2</sup>	lb-in <sup>2</sup>	lb-in <sup>2</sup>	lb-in <sup>2</sup>	lb-in <sup>2</sup>	lb-in <sup>2</sup>	lb	lb	lb
VT204	1.61	0.0023	0.17	0.0006	0.16	0.0023	6.0	4.0	0.50
VT209	1.61	0.0031	0.17	0.0008	0.15	0.0031	6.0	4.0	0.50
VT305	4.34	0.0281	2.30	0.0070	0.37	0.0281	20	15.0	0.73
VT310	4.27	0.0234	2.28	0.0059	0.31	0.0234	20	15.0	0.73
VT320	4.25	0.0200	2.27	0.0050	0.28	0.0200	20	15.0	0.73

<sup>1</sup> Maximum velocity and maximum screw speed may not be achievable at maximum stroke.

<sup>2</sup> Larger Motor or Gearhead Frames and longer stroke lengths are available upon request.

<sup>3</sup> All inertia values are at the input shaft and are representative of typical pulleys, bushings, couplers, etc. Actual values may vary due to motor selection.

<sup>4</sup> Weight values are for reference only and vary depending on configuration.

"U" Parallel offset configuration

"L" Inline configuration

## DATA CURVES FOR THE TAC VT ACTUATOR

### Dynamic Capacity: Life Vs. Load

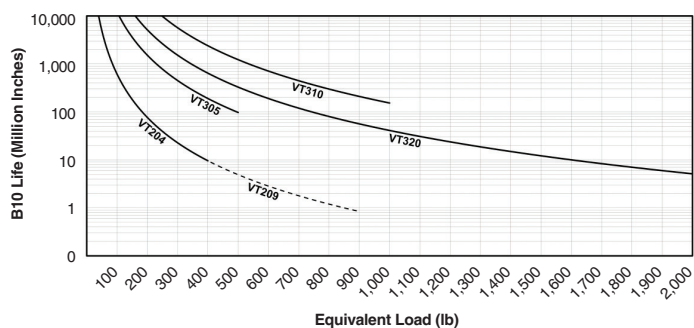

### Speed Vs. Stroke

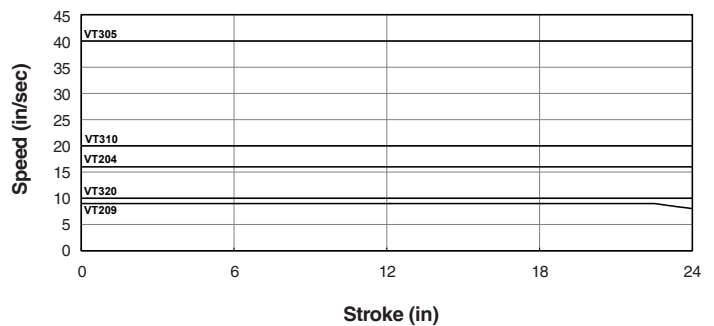

# DIMENSIONED DRAWINGS FOR THE TAC VT ACTUATOR

Dimensions are in inches and are subject to change without notice.

## U-Parallel Offset Motor Configuration

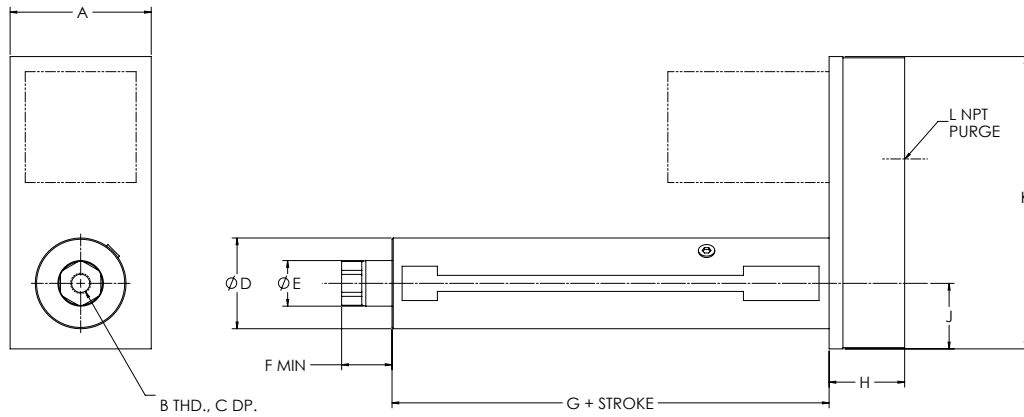

## L-Inline Motor Configuration

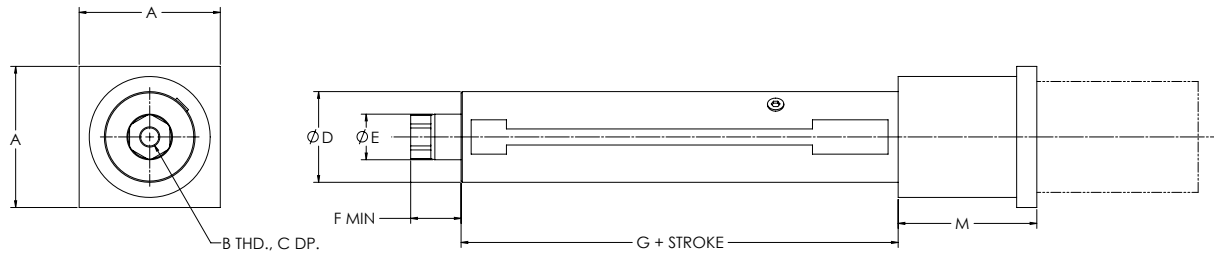

"M" length may vary depending on motor or gearbox.

## Rear Clevis

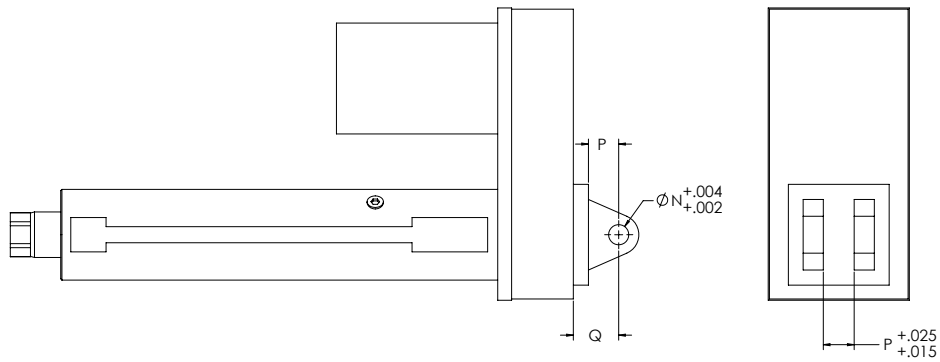

## VT U-Parallel Offset, L-Inline and Rear Clevis Dimensions

Model	A	B	C	D	E	F	G	H	J	K	L	M	N	P	Q
VT204	3.50	1/2-20	0.63	2.25	1.13	1.25	4.84	1.88	1.63	7.25	1/8	3.44	0.50	0.75	1.13
VT209	3.50	1/2-20	0.63	2.25	1.13	1.25	4.84	1.88	1.63	7.25	1/8	3.44	0.50	0.75	1.13
VT305	4.50	3/4-16	0.88	3.25	1.75	1.50	7.03	2.47	2.38	9.63	1/8	3.97	0.75	1.25	1.88
VT310	4.50	3/4-16	0.88	3.25	1.75	1.50	7.03	2.47	2.38	9.63	1/8	3.97	0.75	1.25	1.88
VT320	4.50	3/4-16	0.88	3.25	1.75	1.50	7.03	2.47	2.38	9.63	1/8	3.97	0.75	1.25	1.88

# DIMENSIONED DRAWINGS FOR THE TAC VT ACTUATOR

Dimensions are in inches and are subject to change without notice.

## Bottom Mount Dimensions

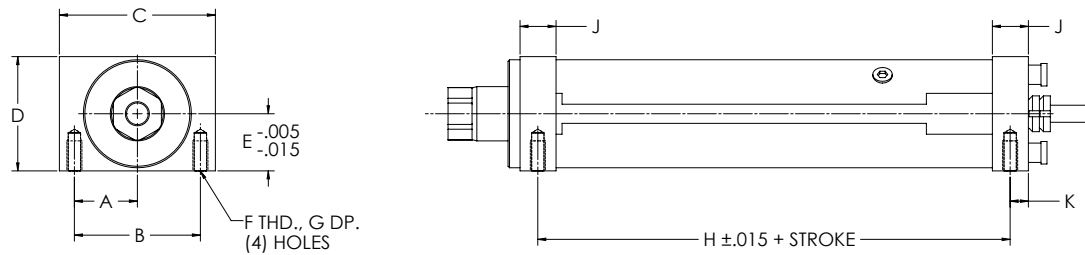

## Front Flange Dimensions

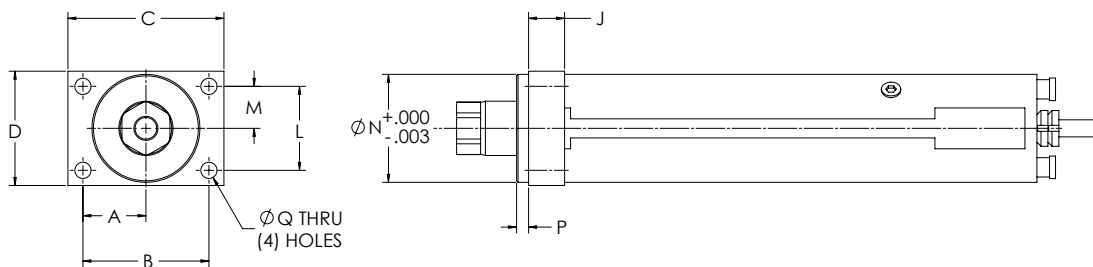

## Foot Mount Dimensions

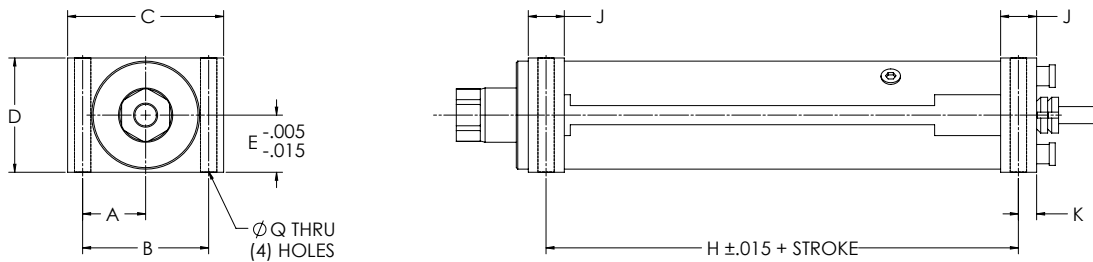

## Trunnion Mount Dimensions

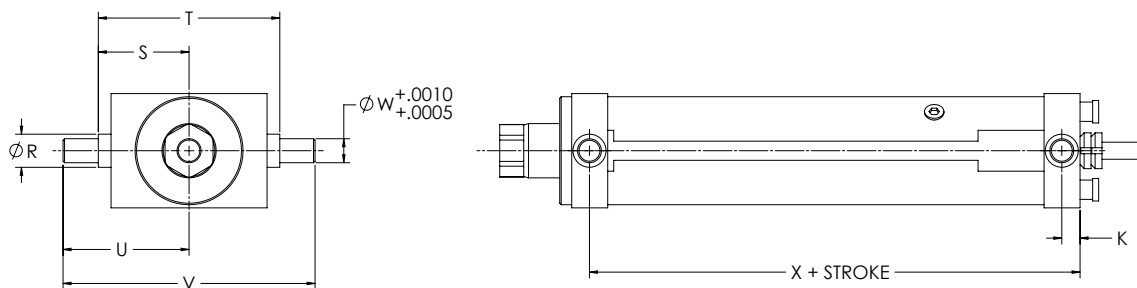

## VT Unit Mounting Dimensions

Model	A	B	C	D	E	F	G	H	J	K	L	M	N	P	Q	R	S	T	U	V	W	X
VT2	1.31	2.63	3.25	2.38	1.19	5/16-18	0.63	3.84	0.75	0.38	1.75	0.88	2.25	0.25	0.34	0.69	1.89	3.78	2.63	5.25	0.50	4.22
VT3	1.88	3.75	4.50	3.38	1.69	3/8-16	0.75	5.78	1.00	0.50	2.63	1.31	3.25	0.25	0.41	0.94	2.52	5.03	3.50	7.00	0.75	6.28

# DIMENSIONED DRAWINGS FOR THE TAC VT ACTUATOR

Dimensions are in inches and are subject to change without notice.

## Rod End Options

### Self-Aligning Coupler

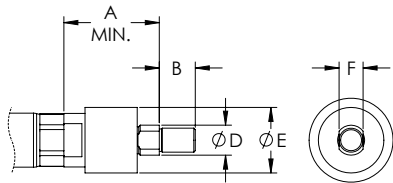

### Male Thread

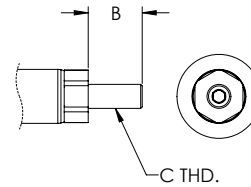

### Spherical Rod Eye

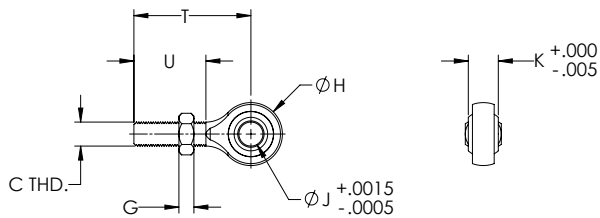

### Female Eye

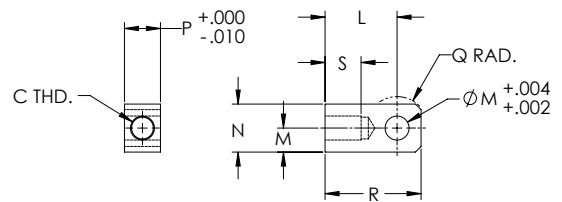

## VT Rod End Dimensions

Model	A	B	C	D	E	F	G	H	J	K	L	M	N	P	Q	R	S	T	U
VT2	2.00	0.75	1/2-20	0.63	1.37	0.50	0.31	1.31	0.50	0.63	1.50	0.50	1.00	0.75	0.50	2.00	0.75	2.44	1.50
VT3	2.31	1.13	3/4-16	0.97	2.00	0.75	0.42	1.75	0.75	0.88	2.06	0.75	1.50	1.25	0.75	2.81	1.13	2.88	1.75

# ORDERING GUIDE FOR THE TAC VT ACTUATOR

## Ordering Information

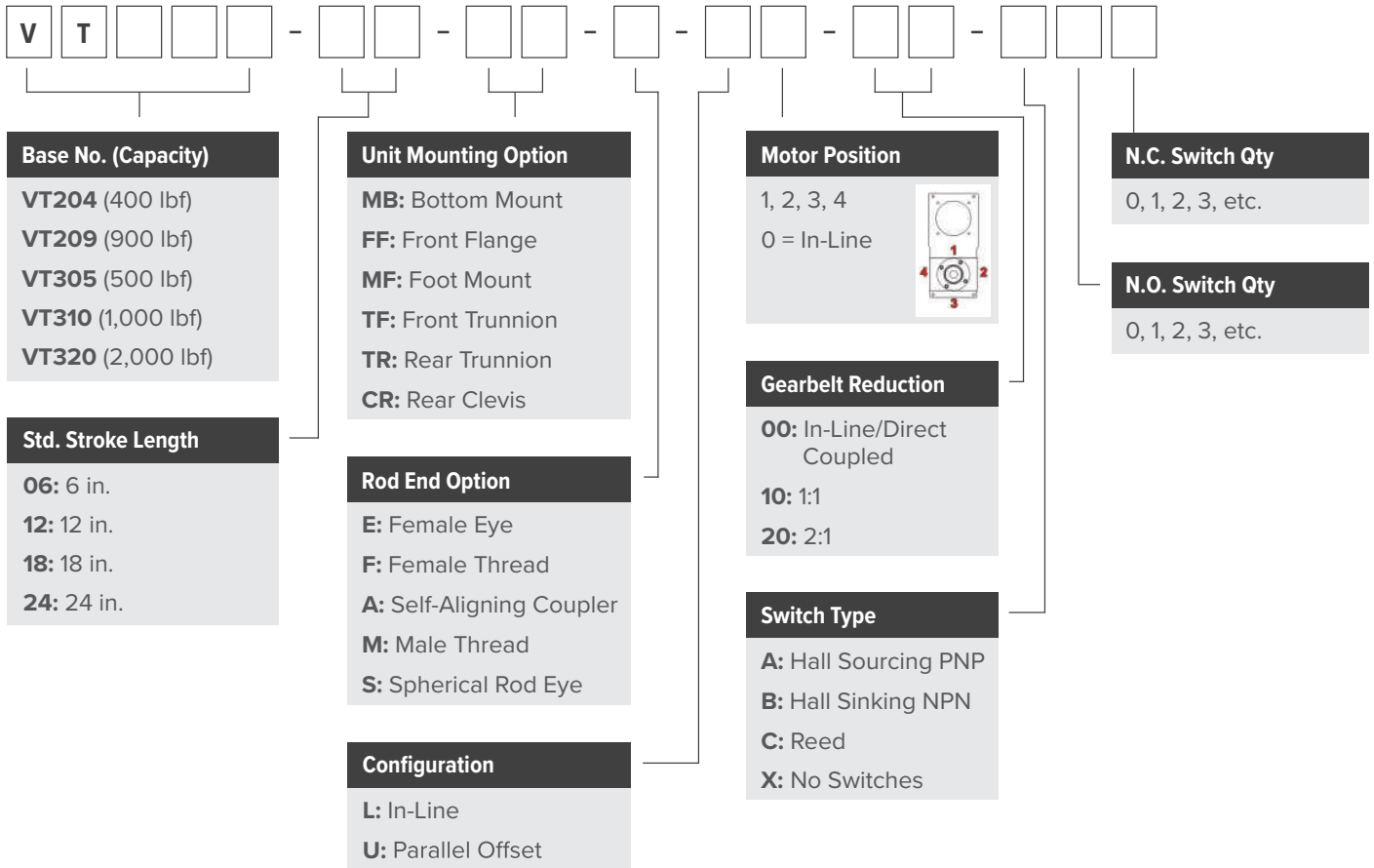

For custom stroke lengths, contact Joyce/Dayton.

# Tac VP™ Actuator

## IP69K STAINLESS STEEL, HIGH QUALITY, HIGH SPEED, HIGH FORCE

Tac VP series stainless steel linear actuators deliver all the performance advantages of our VT actuators with the added benefit of an IP69K rating and a contoured 316 stainless steel housing. Ideally suited for food-grade applications, severe environments and caustic washdown conditions.

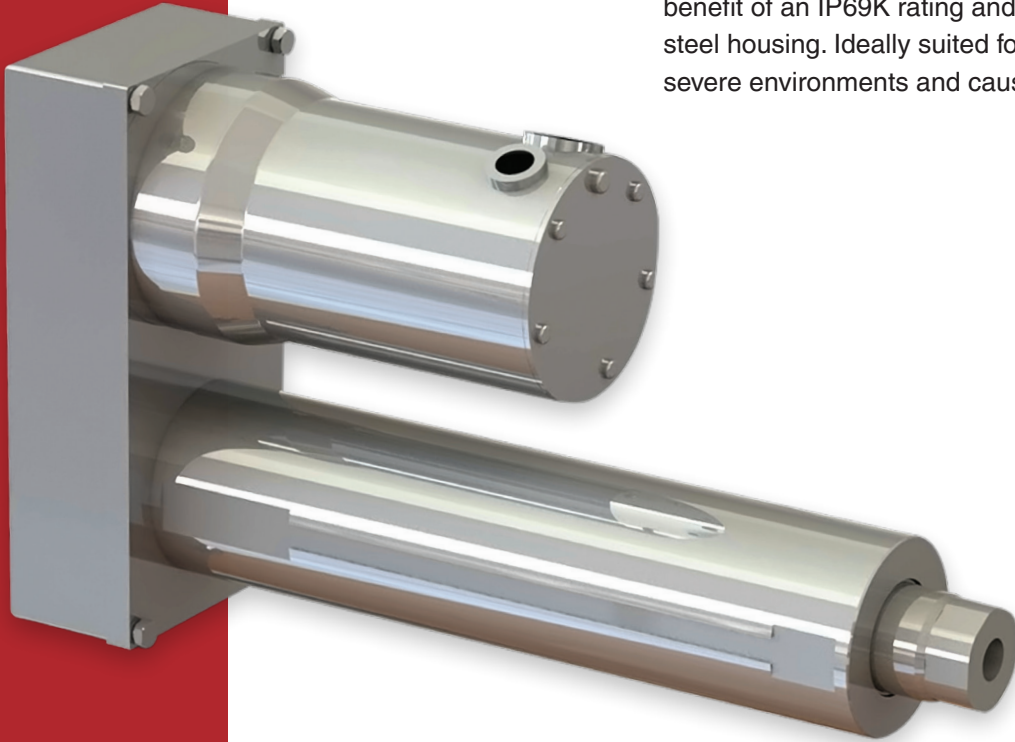

### *Ideal for a Variety of Applications Including:*

- Food and Beverage Conveying / Diverting
- Volumetric Filling / Pumping
- Packaging
- Pneumatic Replacement
- And More

### Key Features:

## IP69K

- IP69K rated for high-pressure, high-temperature washdown
- 316 stainless steel contoured exterior
- Compact actuator with thrust up to 2,000 lbf
- Velocity up to 40 in/sec, stroke up to 24 inches
- Multiple motor/actuator mounting configurations available
- Piston with anti-rotation, sealed chamber design
- 0.003 in/ft standard lead accuracy
- Standard backlash is 0.004 in maximum

# SPECIFICATION CHART FOR THE TAC VP ACTUATOR

Model Number	Thrust Load Rated	Linear Velocity Max. <sup>1</sup>	Travel Length Max. <sup>2</sup>	Frame Size	Lead	Ball Screw Diameter	Ball Screw Max. <sup>1</sup>	Torque @ Ball Screw Max.	Dynamic Capacity Per Million Revs	Dynamic Capacity Per Million Inches	Motor Gearhead Frame Supported Max. <sup>2</sup>
	lb <sup>r</sup>	in/s	in	in	in	in	RPM	in-lb	lb <sup>r</sup>	lb <sup>r</sup>	in
VP204	400	16	24	2.25	0.50	0.50	1,920	35	1,070	850	3.5
VP209	900	9	24	2.25	0.20	0.63	2,700	32	1,410	825	3.5
VP305	500	40	24	3.25	1.00	1.00	2,400	88	2,300	2,300	4.5
VP310	1,000	20	24	3.25	0.50	1.00	2,400	88	5,350	4,250	4.5
VP320	2,000	10	24	3.25	0.25	1.00	2,400	88	5,475	3,450	4.5

Model Number	Inertia 1:1 Zero Stroke <sup>3</sup>	Inertia 1:1 Per Inch of Stroke <sup>3</sup>	Inertia 2:1 Zero Stroke <sup>3</sup>	Inertia 2:1 Per Inch of Stroke <sup>3</sup>	Inertia Inline Zero Stroke <sup>3</sup>	Inertia Inline Per Inch of Stroke <sup>3</sup>	Unit Weight "U" Motor Mount <sup>4</sup>	Unit Weight "L" Motor Mount <sup>4</sup>	Weight Per Inch of Stroke <sup>4</sup>
	lb-in <sup>2</sup>	lb-in <sup>2</sup>	lb-in <sup>2</sup>	lb-in <sup>2</sup>	lb-in <sup>2</sup>	lb-in <sup>2</sup>	lb	lb	lb
VP204	1.61	0.0023	0.17	0.0006	0.16	0.0023	18.0	9.0	0.38
VP209	1.61	0.0031	0.17	0.0008	0.15	0.0031	18.0	9.0	0.38
VP305	4.34	0.0281	2.30	0.0070	0.37	0.0281	33	26.0	0.81
VP310	4.27	0.0234	2.28	0.0059	0.31	0.0234	33	26.0	0.81
VP320	4.25	0.0200	2.27	0.0050	0.28	0.0200	33	26.0	0.81

<sup>1</sup> Maximum velocity and maximum screw speed may not be achievable at maximum stroke.

<sup>2</sup> Larger Motor or Gearhead Frames and longer stroke lengths are available upon request.

<sup>3</sup> All inertia values are at the input shaft and are representative of typical pulleys, bushings, couplers, etc. Actual values may vary due to motor selection.

<sup>4</sup> Weight values are for reference only and vary depending on configuration.

"U" Parallel offset configuration

"L" Inline configuration

\*IP69K rating for static only.

## DATA CURVES FOR THE TAC VP ACTUATOR

### Dynamic Capacity: Life Vs. Load

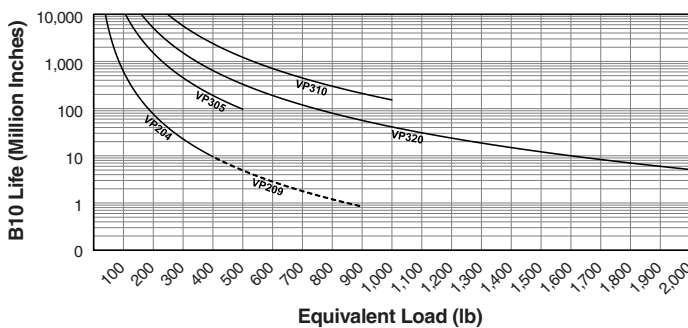

### Speed Vs. Stroke



# DIMENSIONED DRAWINGS FOR THE TAC VP ACTUATOR

Dimensions are in inches and are subject to change without notice.

## U-Parallel Offset Motor Configuration

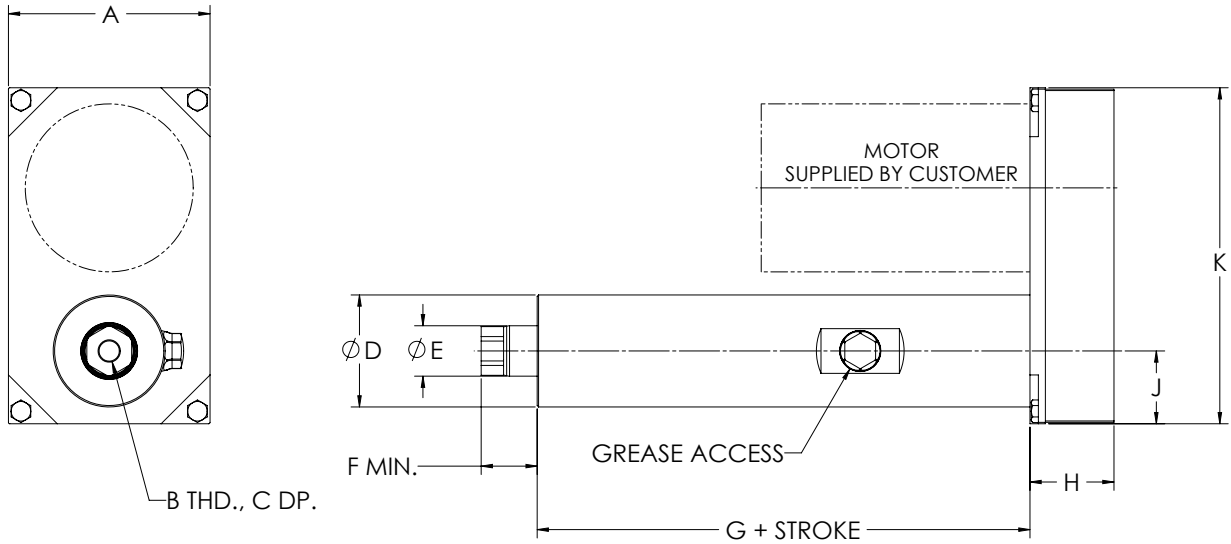

## L-Inline Motor Configuration

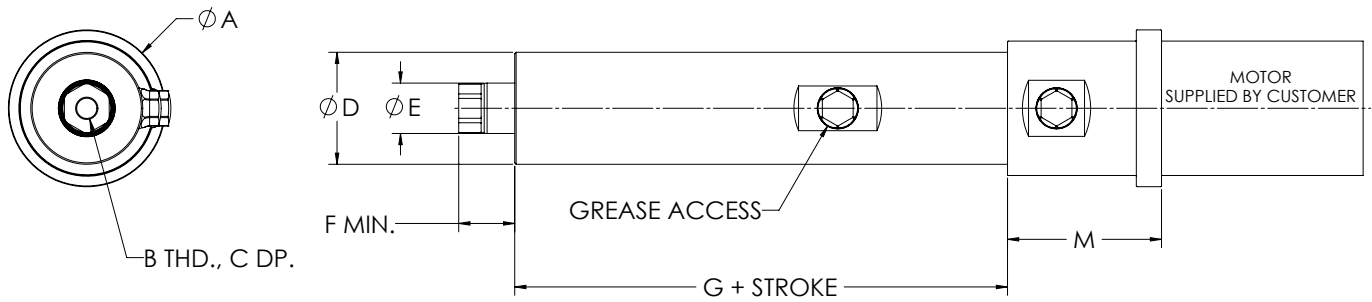

"M" length may vary depending on motor or gearbox.

## VP U-Parallel Offset, L-Inline and Rear Clevis Dimensions

Model	A	B	C	D	E	F	G	H	J	K	L	M
VP204	4.50	1/2-20	0.63	2.50	1.13	1.25	5.03	2.03	1.63	7.50	3.44	3.44
VP209	4.50	1/2-20	0.63	2.50	1.13	1.25	5.03	2.03	1.63	7.50	3.44	3.44
VP305	5.50	3/4-16	0.88	3.50	1.75	1.50	7.28	2.47	2.44	10.13	3.72	3.72
VP310	5.50	3/4-16	0.88	3.50	1.75	1.50	7.28	2.47	2.44	10.13	3.72	3.72
VP320	5.50	3/4-16	0.88	3.50	1.75	1.50	7.28	2.47	2.44	10.13	3.72	3.72

# DIMENSIONED DRAWINGS FOR THE TAC VP ACTUATOR

Dimensions are in inches and are subject to change without notice.

## Bottom Mount Dimensions

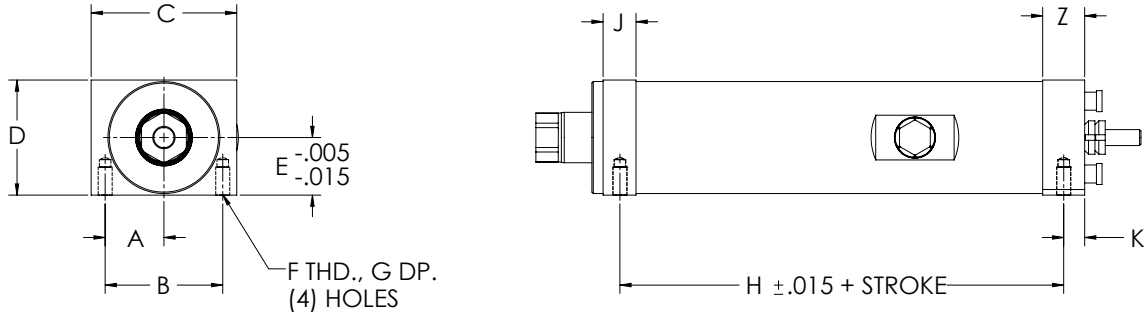

## Front Flange Dimensions

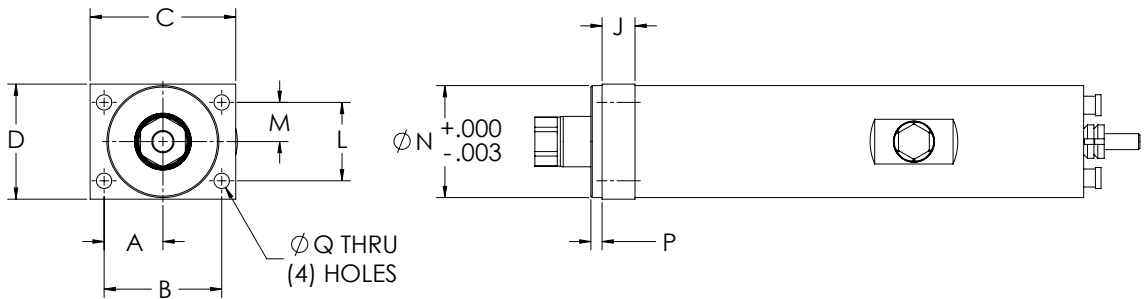

## Foot Mount Dimensions

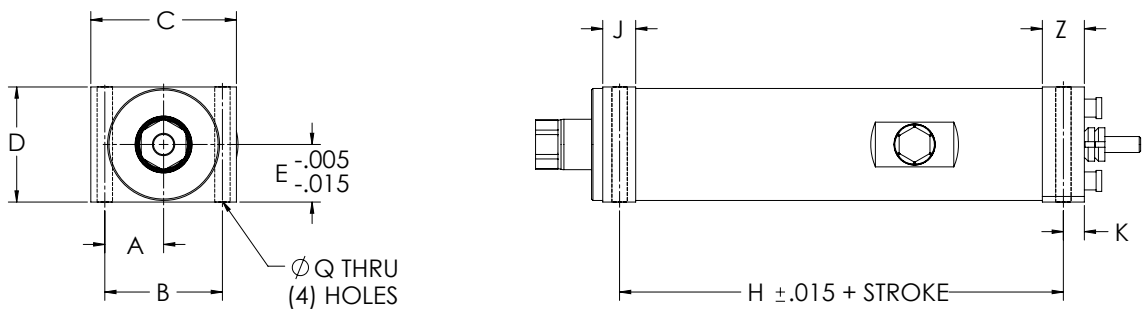

## VP Unit Mounting Dimensions

Model	A	B	C	D	E	F	G	H	J	K	L	M	N	P	Q	Z
VP2	1.31	2.63	3.25	2.57	1.29	5/16-18	0.63	3.84	0.74	0.56	1.75	0.88	2.50	0.25	0.34	0.92
VP3	1.88	3.75	4.50	3.63	1.81	3/8-16	0.75	5.78	1.00	0.75	2.63	1.31	3.50	0.25	0.41	1.25

# DIMENSIONED DRAWINGS FOR THE TAC VP ACTUATOR

Dimensions are in inches and are subject to change without notice.

## Rod End Options

### Self-Aligning Coupler

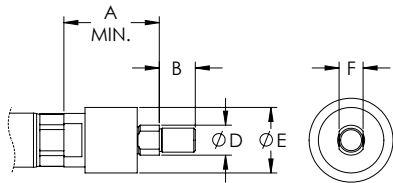

### Male Thread

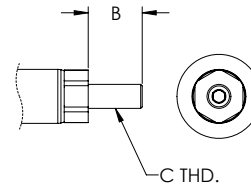

### Spherical Rod Eye

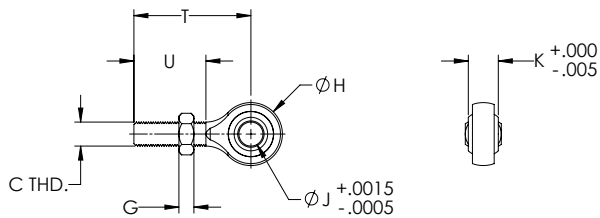

### Female Eye

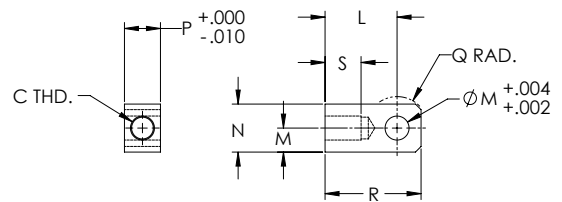

## VP Rod End Dimensions

Model	A	B	C	D	E	F	G	H	J	K	L	M	N	P	Q	R	S	T	U
VP2	2.00	0.75	1/2-20	0.63	1.37	0.50	0.31	1.31	0.50	0.63	1.50	0.50	1.00	0.75	0.63	2.00	0.75	2.44	1.50
VP3	2.38	1.13	3/4-16	0.97	1.75	0.88	0.42	1.75	0.75	0.88	2.06	0.75	1.50	1.25	0.88	2.81	1.13	2.88	1.75

# ORDERING GUIDE FOR THE TAC VP ACTUATOR

## Ordering Information

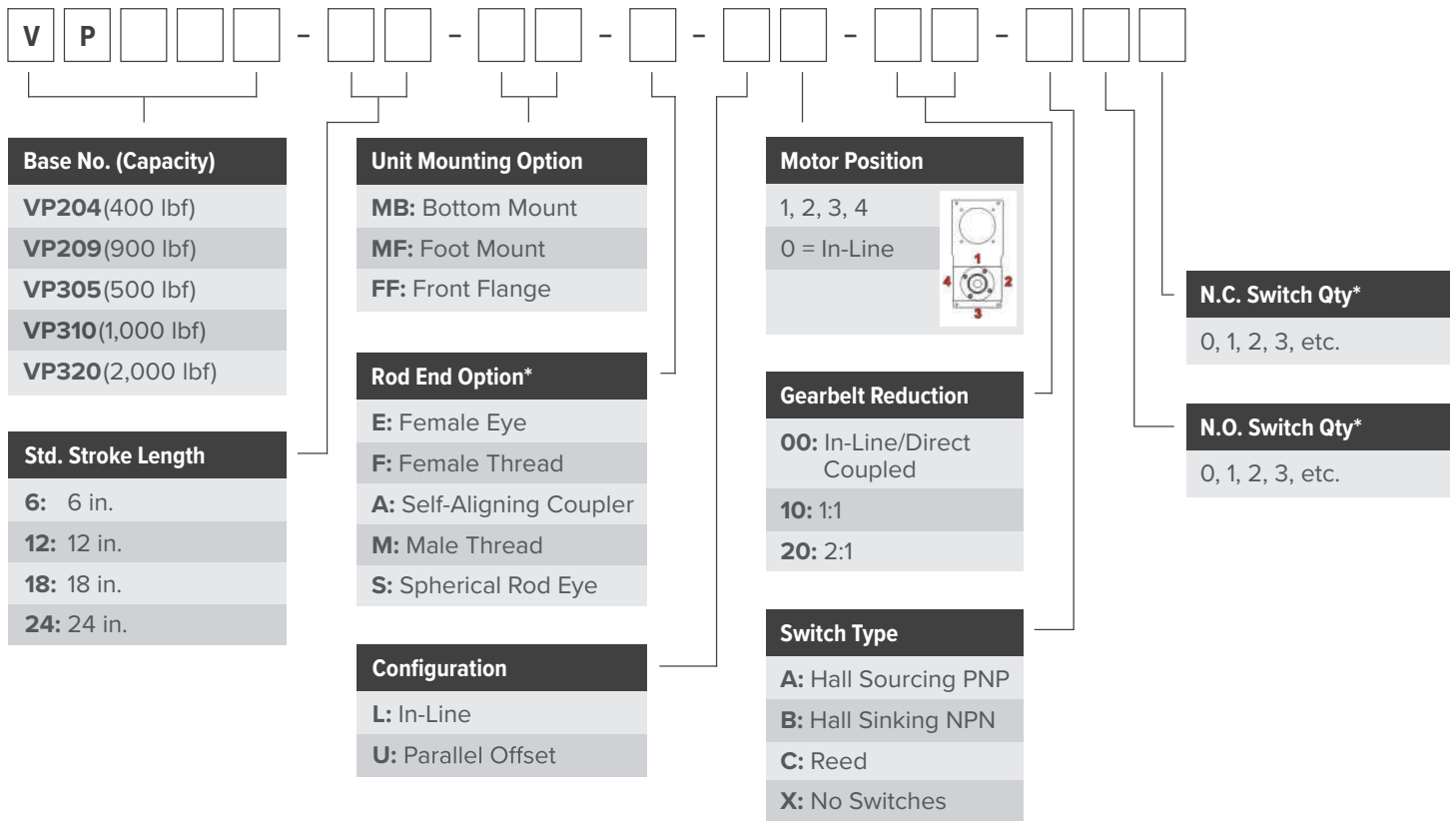

For custom stroke lengths, contact Joyce/Dayton.

\* IP69K Exceptions  
 Self-Aligning Coupler and Spherical Rod Ends not rated  
 Sealed Limit Switches, IP65 rated

# Tac LS™ Actuator

## LONG STROKE, HIGH SPEED, HIGH FORCE

The Tac LS ball screw linear actuator series was developed for long stroke applications. This high quality, durable linear actuator is constructed using rugged aluminum alloy cylinders and chrome plated heavy wall steel pistons. Its small size, as well as the ease of adapting it to any standard unit mounting style, makes the Tac LS electric linear actuators a good fit in most linear motion industrial applications.



### *Ideal for a Variety of Applications Including:*

- Damper Valve Control
- Motion Simulators
- Conveying / Diverting
- Material Handling
- Pneumatic Replacement
- And More

### **Key Features:**

- Developed for long stroke applications
- Small size easily adapts to any standard unit mounting style
- Long stroke actuator with thrust up to 2,000 lbf
- Velocity up to 40 in/sec, stroke from 24 to 60 inches
- 0.003 in/ft standard lead accuracy
- Standard backlash is 0.004 in maximum

# SPECIFICATION CHART FOR THE TAC LS ACTUATOR

Model Number	Thrust Load Rated	Linear Velocity Max. <sup>1</sup>	Travel Length Max. <sup>2</sup>	Frame Size	Lead	Ball Screw Diameter	Ball Screw Max. <sup>1</sup>	Torque @ Ball Screw Max.	Dynamic Capacity Per Million Revs	Dynamic Capacity Per Million Inches	Motor Gearhead Frame Supported Max. <sup>2</sup>
	lb <sup>r</sup>	in/s	in	in	in	in	RPM	in-lb	lb <sup>r</sup>	lb <sup>r</sup>	in
LS204	400	16	36	2.25	0.500	0.50	1,920	35	1,070	850	3.5
LS209	900	8	36	2.25	0.200	0.63	2,400	32	1,410	825	3.5
LS305	500	40	60	3.25	1.000	1.00	2,400	88	2,300	2,300	4.5
LS310	1,000	20	60	3.25	0.500	1.00	2,400	88	5,350	4,250	4.5
LS320	2,000	10	54	3.25	0.250	1.00	2,400	88	5,475	3,450	4.5

Model Number	Inertia 1:1 Zero Stroke <sup>3</sup>	Inertia 1:1 Per Inch of Stroke <sup>3</sup>	Inertia 2:1 Zero Stroke <sup>3</sup>	Inertia 2:1 Per Inch of Stroke <sup>3</sup>	Inertia Inline Zero Stroke <sup>3</sup>	Inertia Inline Per Inch of Stroke <sup>3</sup>	Unit Weight "U" Motor Mount <sup>4</sup>	Unit Weight "L" Motor Mount <sup>4</sup>	Weight Per Inch of Stroke <sup>4</sup>
	lb-in <sup>2</sup>	lb-in <sup>2</sup>	lb-in <sup>2</sup>	lb-in <sup>2</sup>	lb-in <sup>2</sup>	lb-in <sup>2</sup>	lb	lb	lb
LS204	1.61	0.0023	0.17	0.0006	0.16	0.0023	3.0	2.0	0.50
LS209	1.61	0.0031	0.17	0.0008	0.15	0.0031	3.0	2.0	0.50
LS305	4.37	0.0535	2.30	0.0134	0.41	0.0535	10	7.0	0.83
LS310	4.28	0.0298	2.28	0.0074	0.32	0.0298	10	7.0	0.83
LS320	4.25	0.0216	2.27	0.0054	0.29	0.0216	10	7.0	0.83

<sup>1</sup> Maximum velocity and maximum screw speed may not be achievable at maximum stroke.

<sup>2</sup> Larger Motor or Gearhead Frames and longer stroke lengths are available upon request.

<sup>3</sup> All inertia values are at the input shaft and are representative of typical pulleys, bushings, couplers, etc. Actual values may vary due to motor selection.

<sup>4</sup> Weight values are for reference only and vary depending on configuration.

"U" Parallel offset configuration

"L" Inline configuration

## DATA CURVES FOR THE TAC LS ACTUATOR

### Dynamic Capacity: Life Vs. Load

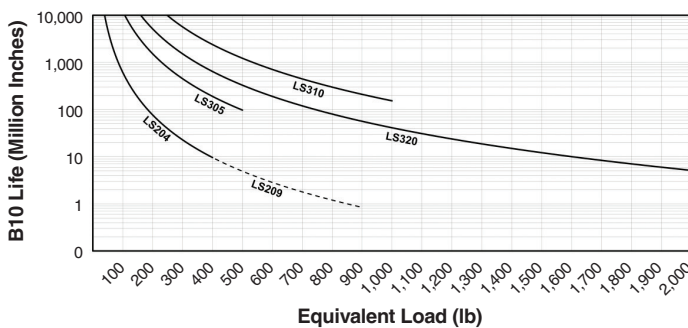

### Speed Vs. Stroke

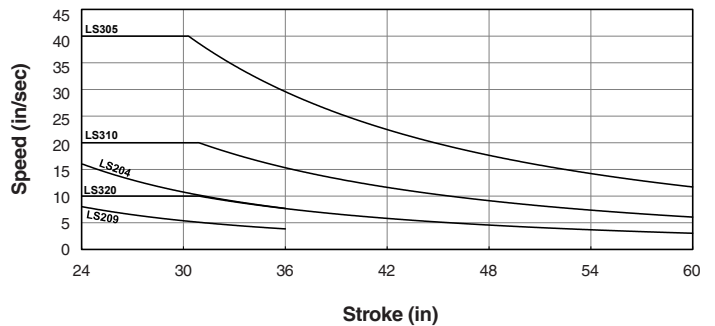

# DIMENSIONED DRAWINGS FOR THE TAC LS ACTUATOR

Dimensions are in inches and are subject to change without notice.

## U-Parallel Offset Motor Configuration

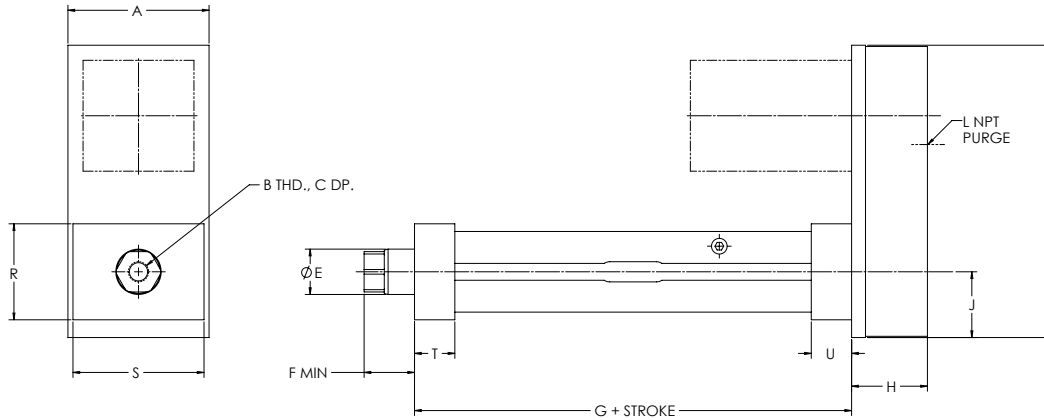

## L-Inline Motor Configuration

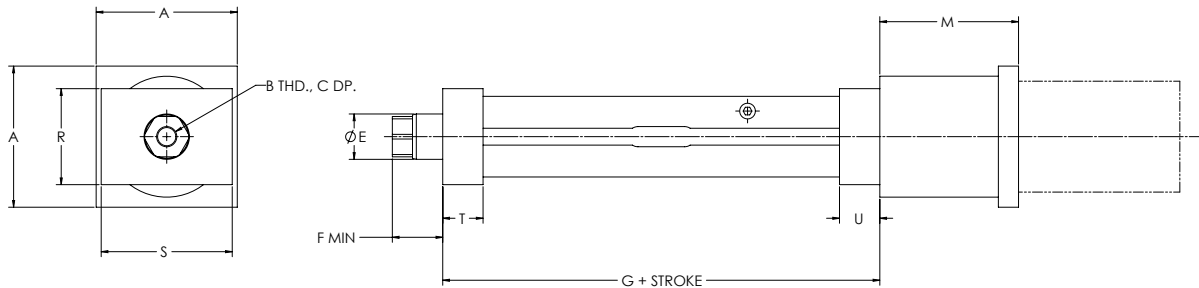

"M" length may vary depending on motor or gearbox.

## Rear Clevis

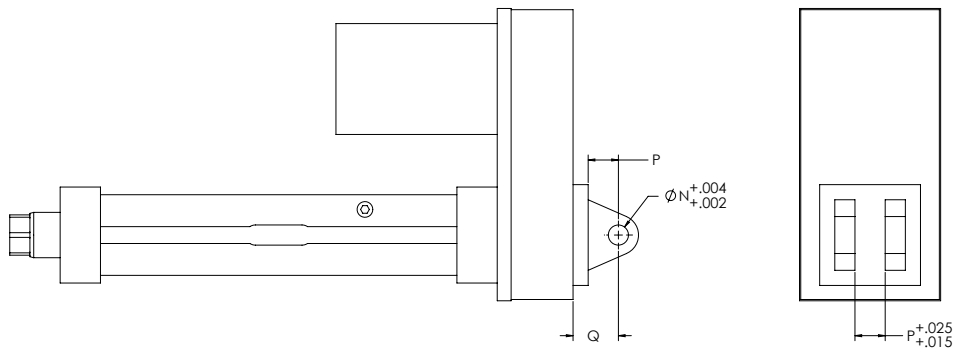

## LS U-Parallel Offset, L-Inline and Rear Clevis Dimensions

Model	A	B	C	D	E	F	G	H	J	K	L	M	N	P	Q	R	S	T	U
LS204	3.50	1/2-20	0.63	2.25	1.13	1.25	7.84	1.88	1.63	7.25	1/8	3.44	0.50	0.75	1.13	2.38	3.25	1.00	1.00
LS209	3.50	1/2-20	0.63	2.25	1.13	1.25	7.84	1.88	1.63	7.25	1/8	3.44	0.50	0.75	1.13	2.38	3.25	1.00	1.00
LS305	4.50	3/4-16	0.88	3.25	1.75	1.50	10.16	2.47	2.38	9.63	1/8	3.97	0.75	1.25	1.88	3.38	4.50	1.25	1.38
LS310	4.50	3/4-16	0.88	3.25	1.75	1.50	10.16	2.47	2.38	9.63	1/8	3.97	0.75	1.25	1.88	3.38	4.50	1.25	1.38
LS320	4.50	3/4-16	0.88	3.25	1.75	1.50	10.16	2.47	2.38	9.63	1/8	3.97	0.75	1.25	1.88	3.38	4.50	1.25	1.38

# DIMENSIONED DRAWINGS FOR THE TAC LS ACTUATOR

Dimensions are in inches and are subject to change without notice.

## Bottom Mount Dimensions

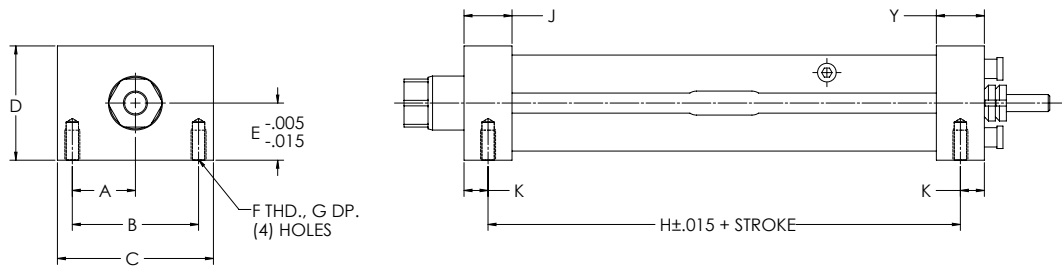

## Front Flange Dimensions

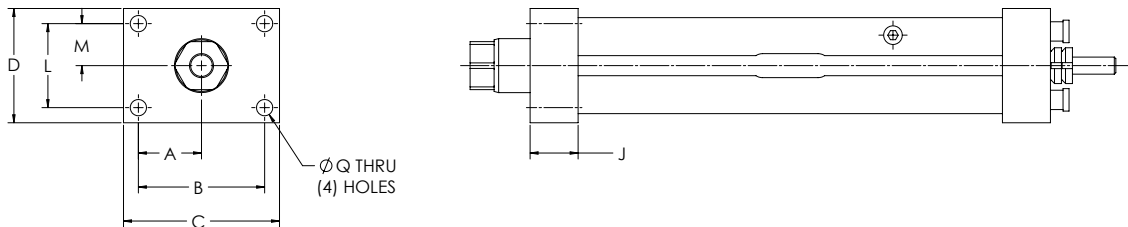

## Foot Mount Dimensions

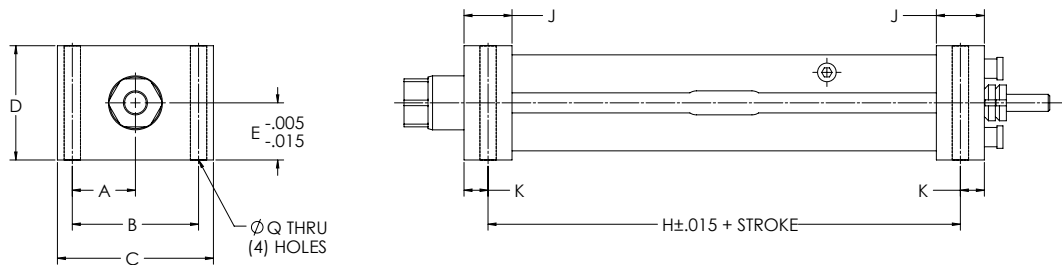

## Trunnion Mount Dimensions

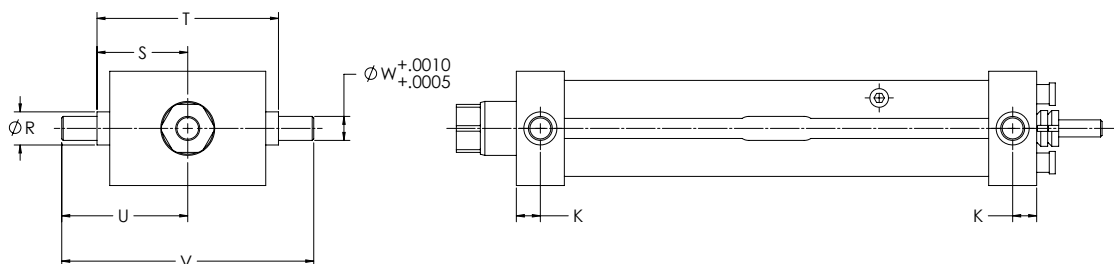

## LS Unit Mounting Dimensions

Model	A	B	C	D	E	F	G	H	J	K	L	M	N	P	Q	R	S	T	U	V	W	X	Y
LS2	1.31	2.63	3.25	2.38	1.19	5/16-18	0.63	6.84	1.00	0.50	1.75	0.88	2.25	0.25	0.34	0.69	1.89	3.78	2.63	5.25	0.50	4.22	1.00
LS3	1.88	3.75	4.50	3.38	1.69	3/8-16	0.75	9.16	1.25	0.50	2.63	1.31	3.25	0.25	0.41	0.94	2.52	5.03	3.50	7.00	0.75	6.28	1.38

# DIMENSIONED DRAWINGS FOR THE TAC LS ACTUATOR

Dimensions are in inches and are subject to change without notice.

## Rod End Options

### Self-Aligning Coupler

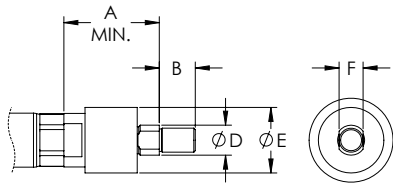

### Male Thread

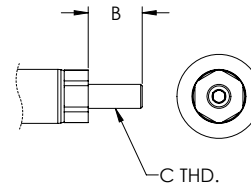

### Spherical Rod Eye

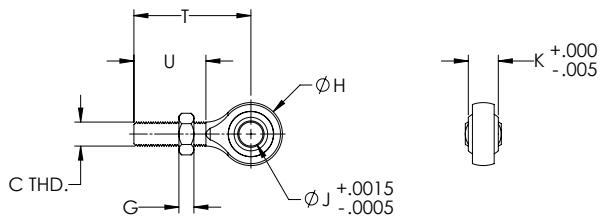

### Female Eye

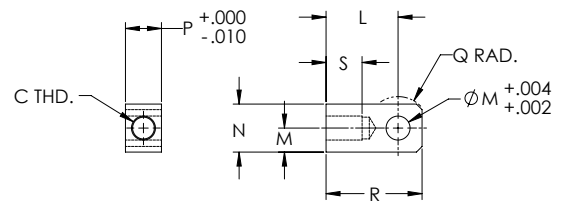

## LS Rod End Dimensions

Model	A	B	C	D	E	F	G	H	J	K	L	M	N	P	Q	R	S	T	U
LS2	2.00	0.75	1/2-20	0.63	1.37	0.50	0.31	1.31	0.50	0.63	1.50	0.50	1.00	0.75	0.50	2.00	0.75	2.44	1.50
LS3	2.31	1.13	3/4-16	0.97	2.00	0.75	0.42	1.75	0.75	0.88	2.06	0.75	1.50	1.25	0.75	2.81	1.13	2.88	1.75

# ORDERING GUIDE FOR THE TAC LS ACTUATOR

## Ordering Information

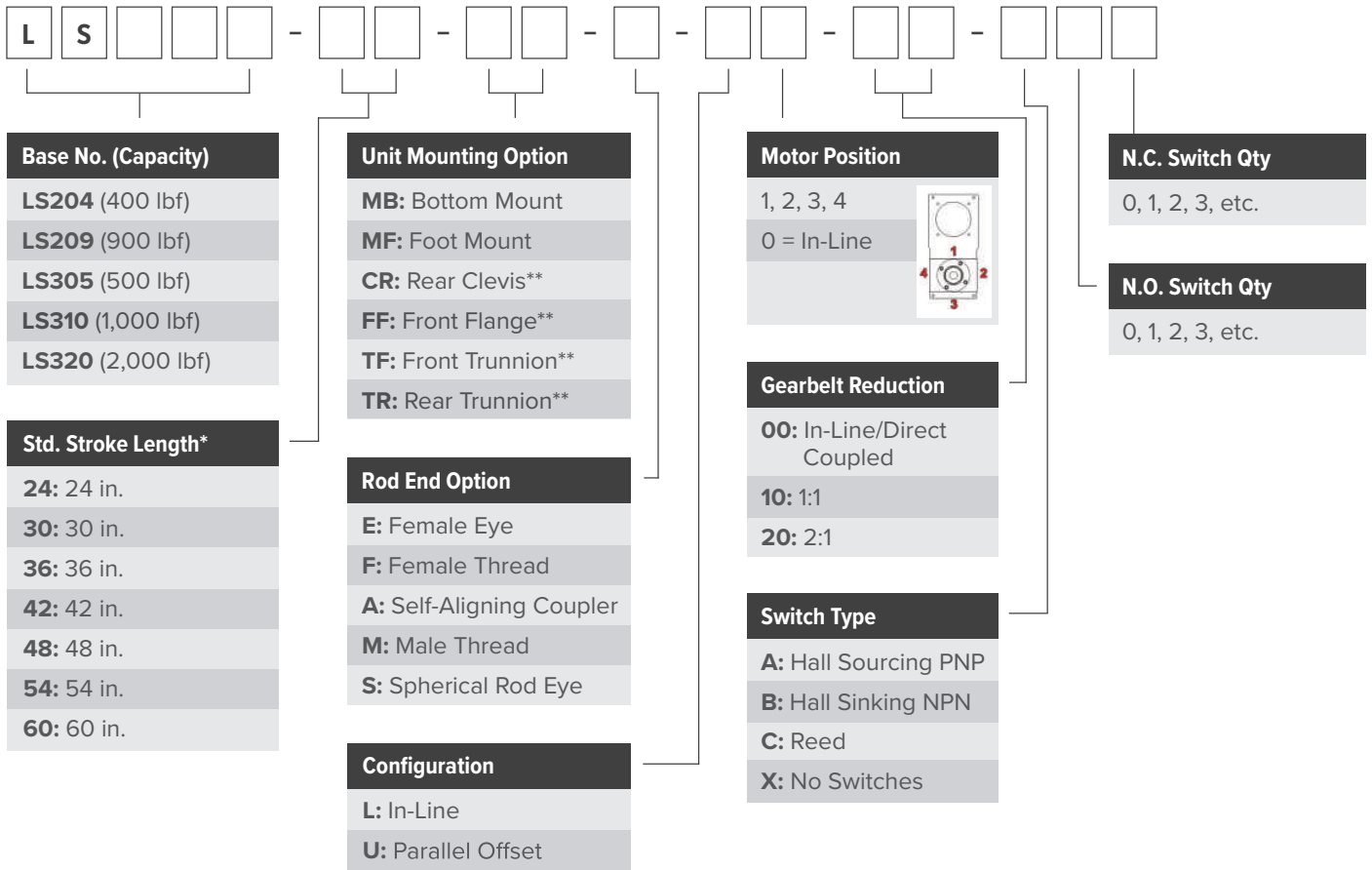

For custom stroke lengths, contact Joyce/Dayton.

\* LS204 – LS209 are available with stroke lengths up to 36 in.  
 LS305 – LS310 are available with stroke lengths from 30 in. to 60 in.  
 LS320 are available with stroke lengths from 30 in. to 54 in.

\*\* Vertical Mounting Only

# Eliminator HD™ Actuator

## HEAVY DUTY, HIGH SPEED, HIGH FORCE, HIGH PRECISION

The Eliminator HD and HDL series Heavy Duty linear actuators provide strong, durable, and precise linear motion for industrial automation. The HD was designed to replace hydraulic actuators and thus “eliminate” many associated concerns, such as noise and fluid leakage, while providing high load, high speed, and high accuracy linear motion that is controllable, repeatable, and easy to adjust.

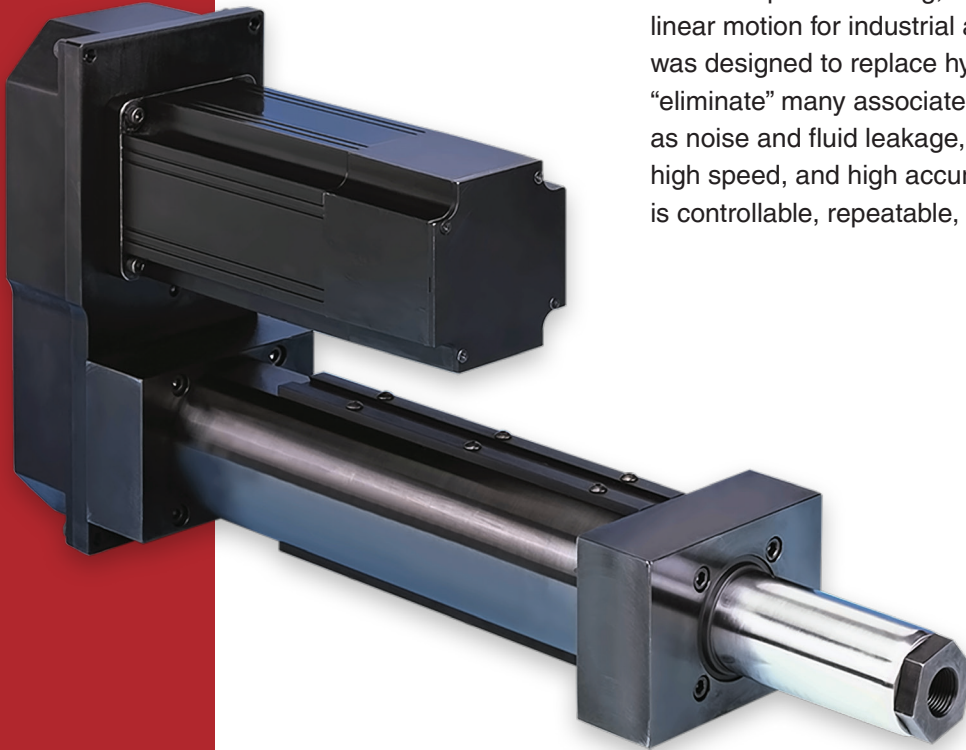

### *Ideal for a Variety of Applications Including:*

- Pressing / Punching
- Material Handling
- Metal Forming
- Parts Clamping
- Assembly
- Heat Staking
- Hydraulic Replacement
- And More

### **Key Features:**

- Rugged steel construction with durable anti-rotation feature
- Rated thrust up to 40,000 lbf
- High velocity up to 20 in/sec, stroke up to 48 inches
- Integrated load cell option provides continuous bi-directional measurement of applied loads (HDL model)
- 0.002 in/ft standard lead accuracy, 0.0005 in/ft optional lead accuracy
- Standard backlash is 0.003 in maximum; optional zero backlash is also available

# SPECIFICATION CHART FOR THE ELIMINATOR HD ACTUATOR

Model Number	Thrust Load Rated	Linear Velocity Max. <sup>1</sup>	Travel Length Max. <sup>2</sup>	Frame Size	Lead	Ball Screw Diameter	Ball Screw Max. <sup>1</sup>	Torque @ Ball Screw Max.	Dynamic Capacity Per Million Revs	Dynamic Capacity Per Million Inches	Motor Gearhead Frame Supported Max. <sup>2</sup>
	lb <sup>r</sup>	in/s	in	in	mm	mm	RPM	in-lb	lb <sup>r</sup>	lb <sup>r</sup>	in
HD201	1,000	8.0	12	2.00	4	16	3,048	28	1,529	825	2.75
HD302	2,000	20.0	36	3.00	10	25	3,048	139	6,490	4,760	4.25
HD304	4,000	20.0	36	3.00	10	25	3,048	278	6,490	4,760	4.25
HD404	4,000	18.0	42	4.00	10	32	2,743	278	14,580	10,690	5.75
HD406	6,000	18.0	42	4.00	10	32	2,743	418	14,580	10,690	5.75
HD508	8,000	14.0	48	5.00	12	50	1,778	668	31,250	24,340	8.00
HD516	16,000	14.0	48	5.00	12	50	1,778	1,337	31,250	24,340	8.00
HD618	18,000	9.8	48	6.00	12	63	1,245	1,504	35,750	27,840	8.00
HD625	25,000	14.4	48	6.00	20	80	1,097	3,481	52,150	48,160	8.00
HD740	40,000	14.1	48	7.00	20	80	1,097	5,575	52,150	48,160	10.88

Model Number	Inertia 1:1 Zero Stroke <sup>3</sup>	Inertia 1:1 Per Inch of Stroke <sup>3</sup>	Inertia 2:1 Zero Stroke <sup>3</sup>	Inertia 2:1 Per Inch of Stroke <sup>3</sup>	Inertia Inline Zero Stroke <sup>3</sup>	Inertia Inline Per Inch of Stroke <sup>3</sup>	Unit Weight "U" Motor Mount <sup>4</sup>	Unit Weight "L" Motor Mount <sup>4</sup>	Weight Per Inch of Stroke <sup>4</sup>
	lb-in <sup>2</sup>	lb-in <sup>2</sup>	lb-in <sup>2</sup>	lb-in <sup>2</sup>	lb-in <sup>2</sup>	lb-in <sup>2</sup>	lb	lb	lb
HD201	0.51	0.0031	0.27	0.0008	0.04	0.0031	8	6	0.87
HD302	4.31	0.0212	1.64	0.0053	0.34	0.0212	29	22	1.33
HD304	4.87	0.0212	1.46	0.0053	0.38	0.0212	29	22	1.33
HD404	23.24	0.0457	4.11	0.0114	1.99	0.0457	63	49	2.25
HD406	23.24	0.0457	4.11	0.0114	1.99	0.0457	63	49	2.25
HD508	139.27	0.2688	22.66	0.0672	5.92	0.2688	155	105	3.40
HD516	139.36	0.2688	22.68	0.0672	6.00	0.2688	155	105	3.40
HD618	281.96	0.7361	43.91	0.1840	12.31	0.7361	207	152	5.50
HD625	295.02	1.8713	47.17	0.4678	25.37	1.8713	214	158	5.50
HD740	401.85	1.8707	64.87	0.4677	96.29	1.8707	373	318	7.41

<sup>1</sup> Maximum velocity and maximum screw speed may not be achievable at maximum stroke.

<sup>2</sup> Larger Motor or Gearhead Frames and longer stroke lengths are available upon request.

<sup>3</sup> All inertia values are at the input shaft and are representative of typical pulleys, bushings, couplers, etc. Actual values may vary due to motor selection.

<sup>4</sup> Weight values are for reference only and vary depending on configuration.

"U" Parallel offset configuration

"L" Inline configuration

## DATA CURVES FOR THE ELIMINATOR HD ACTUATOR

### Dynamic Capacity: Life Vs. Load

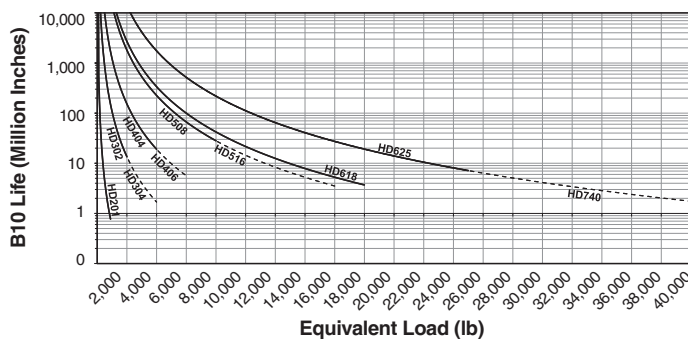

### Speed Vs. Stroke

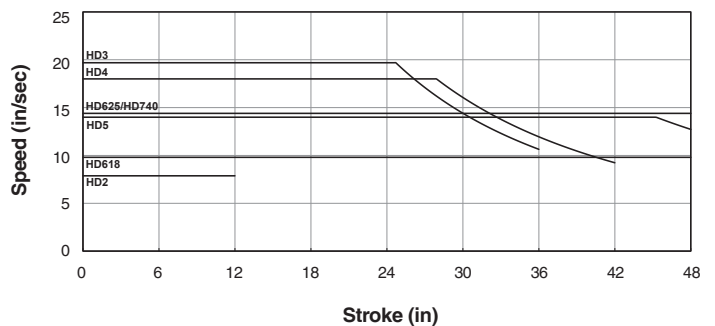

# DIMENSIONED DRAWINGS FOR THE ELIMINATOR HD ACTUATOR

Dimensions are in inches and are subject to change without notice.

## U-Parallel Offset Motor Configuration

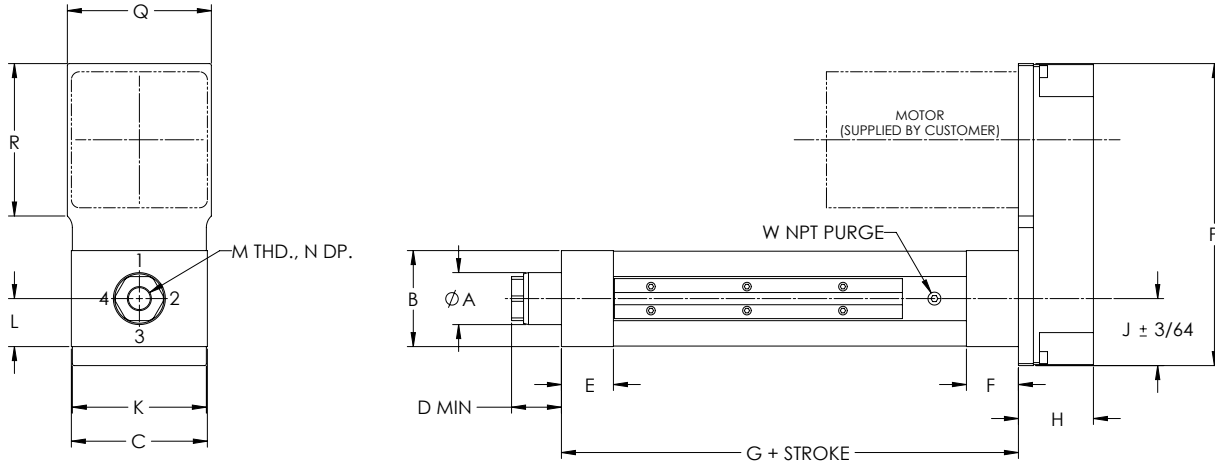

## L-Inline Motor Configuration

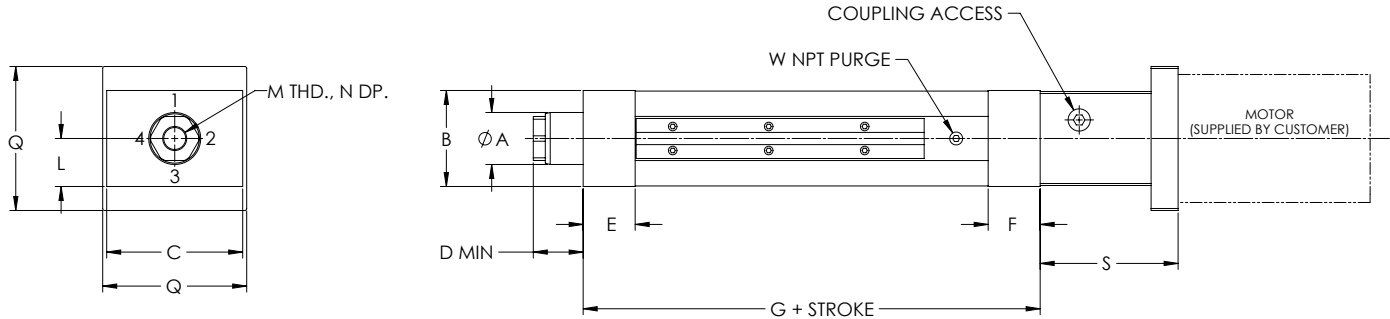

"S" length may vary depending on motor or gearbox.

## HD U-Parallel Offset and L-Inline Motor Configuration

Model	A	B	C	D	E	F	G	H	J	K	L	M	N	P	Q	R	S	W
HD201	1.13	2.00	3.00	1.04	1.00	1.00	5.59	1.63	1.48	2.97	1.00	1/2-20	1.00	6.30	2.97	N/A	2.66	1/8
HD302	1.63	3.00	4.25	1.41	1.63	1.63	8.28	2.34	2.09	4.19	1.50	3/4-16	1.00	9.44	4.50	4.75	4.31	1/8
HD304	1.63	3.00	4.25	1.56	1.63	1.63	8.28	2.34	2.09	4.19	1.50	3/4-16	1.00	9.44	4.50	4.75	4.31	1/8
HD404	2.25	4.00	5.50	1.88	2.00	2.00	9.59	2.63	2.69	5.38	2.00	3/4-16	1.00	13.00	6.00	6.94	5.00	1/4
HD406	2.25	4.00	5.50	1.79	2.00	2.00	9.59	2.63	2.69	5.38	2.00	3/4-16	1.00	13.00	6.00	6.94	5.00	1/4
HD508	3.00	5.00	7.75	2.56	2.50	3.00	13.38	4.03	3.81	7.63	2.50	1 1/4-12	1.63	17.19	8.38	9.19	6.75	3/8
HD516	3.00	5.00	7.75	2.56	2.50	3.00	13.38	4.03	3.81	7.63	2.50	1 1/4-12	1.63	17.19	8.38	9.19	6.75	3/8
HD618	3.50	6.00	8.50	2.75	3.00	3.00	14.00	4.13	4.13	8.38	3.00	1 1/4-12	1.63	17.88	9.00	9.19	7.25	1/2
HD625	4.00	6.00	8.50	2.75	3.00	3.00	16.75	4.13	4.13	8.38	3.00	1 1/4-12	1.63	17.88	9.00	9.19	7.25	1/2
HD625	4.25	7.00	10.00	3.77	3.50	4.50	18.96	5.44	4.94	9.88	3.50	2-12	3.00	19.88	10.94	10.05	10.17	1/2

# DIMENSIONED DRAWINGS FOR THE ELIMINATOR HD ACTUATOR

Dimensions are in inches and are subject to change without notice.

## Bottom Mount Dimensions

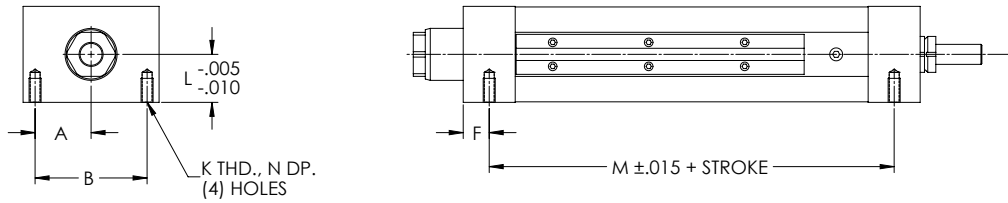

## Front Flange Dimensions

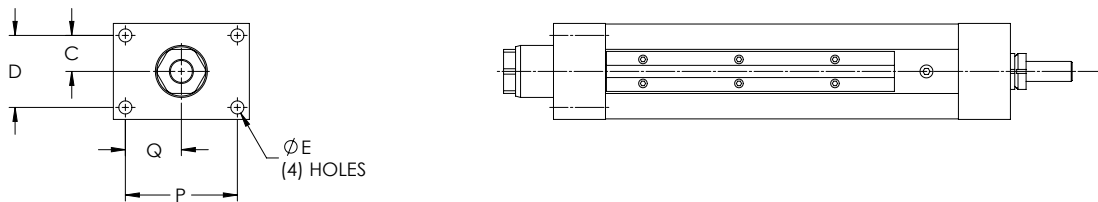

## Foot Mount Dimensions

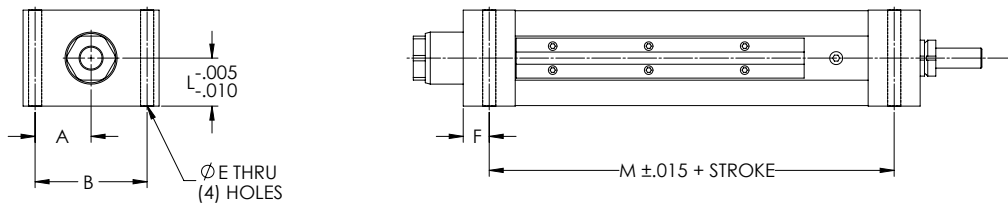

## Trunnion Mount Dimensions

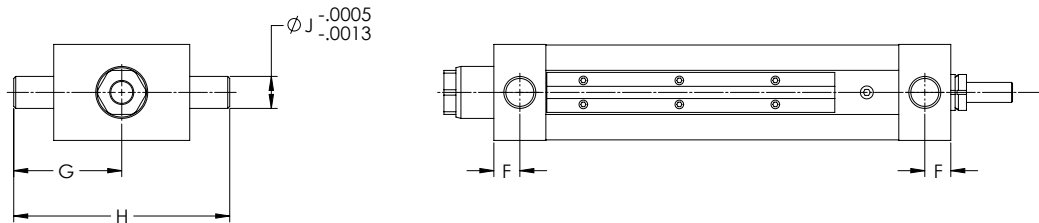

## HD Mounting Dimensions (Bottom Mount, Front Flange, Foot Mount, Trunnion Mount)

Model	A	B	C	D	E	F	G	H	J	K	L	M	N	P	Q
HD201	1.13	2.25	0.69	1.38	0.34	0.49	2.24	4.48	0.50	5/16-18	0.99	4.63	0.63	2.38	1.19
HD302	1.75	3.50	1.13	2.25	0.41	0.81	3.38	6.75	1.00	3/8-16	1.50	6.66	0.75	3.50	1.75
HD304	1.75	3.50	1.13	2.25	0.41	0.81	3.38	6.75	1.00	3/8-16	1.50	6.66	0.75	3.50	1.75
HD404	2.19	4.38	1.44	2.88	0.69	1.00	4.50	9.00	1.25	5/8-11	2.00	7.59	1.00	4.38	2.19
HD406	2.19	4.38	1.44	2.88	0.69	1.00	4.50	9.00	1.25	5/8-11	2.00	7.59	1.00	4.38	2.19
HD508	3.13	6.25	1.75	3.50	0.81	1.25	6.25	12.50	1.50	3/4-10	2.50	10.63	1.25	6.25	3.13
HD516	3.13	6.25	1.75	3.50	0.81	1.25	6.25	12.50	1.50	3/4-10	2.50	10.63	1.25	6.25	3.13
HD618	3.31	6.63	2.00	4.00	1.06	1.50	7.13	14.25	2.00	1-8	3.00	11.00	1.63	6.63	3.31
HD625	3.31	6.63	2.00	4.00	1.06	1.50	7.13	14.25	2.00	1-8	3.00	13.75	1.63	6.63	3.31
HD740	4.00	8.00	2.50	5.00	1.06	1.75	7.88	15.75	2.00	1-8	3.50	14.96	2.00	8.00	4.00

# DIMENSIONED DRAWINGS FOR THE ELIMINATOR HD ACTUATOR

Dimensions are in inches and are subject to change without notice.

## Rod End Options

### Self-Aligning Coupler

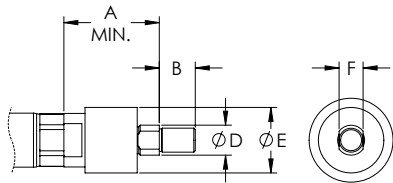

### Male Thread

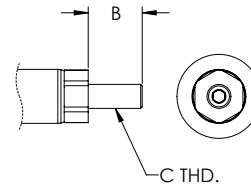

### Spherical Rod Eye

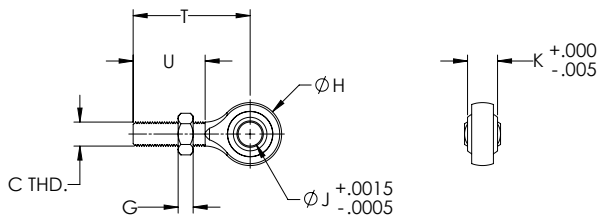

### Female Eye

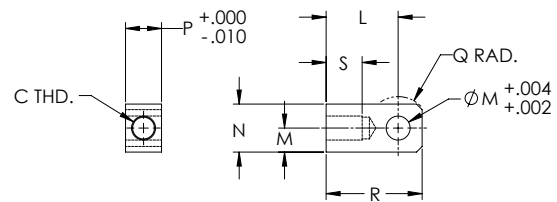

## HD Rod End Dimensions

Model	A	B	C	D	E	F	G	H	J	K	L	M	N	P	Q	R	S	T	U
HD201	2.00	0.75	1/2-20	0.63	1.37	0.50	0.31	1.31	0.50	0.63	1.50	0.50	1.00	0.75	0.50	2.00	0.75	2.44	1.50
HD302	2.31	1.13	3/4-16	0.97	2.00	0.75	0.42	1.75	0.75	0.88	2.06	0.75	1.50	1.25	0.75	2.81	1.13	2.88	1.75
HD304	2.31	1.13	3/4-16	0.97	2.00	0.75	0.42	1.75	0.75	0.88	2.06	0.75	1.50	1.25	0.75	2.81	1.13	2.88	1.75
HD404	2.31	1.13	3/4-16	0.97	2.00	0.75	0.42	1.75	0.75	0.88	2.06	0.75	1.50	1.25	0.75	2.81	1.13	2.88	1.75
HD406	2.31	1.13	3/4-16	0.97	2.00	0.75	0.42	1.75	0.75	0.88	2.06	0.75	1.50	1.25	0.75	2.81	1.13	2.88	1.75
HD508	2.94	1.63	1 1/4-12	1.45	3.13	1.25	0.72	2.75	1.00	1.38	3.44	1.38	2.75	2.00	1.38	4.81	2.00	4.13	2.13
HD516	2.94	1.63	1 1/4-12	1.45	3.13	1.25	0.72	2.75	1.00	1.38	3.44	1.38	2.75	2.00	1.38	4.81	2.00	4.13	2.13
HD618	2.94	1.63	1 1/4-12	1.45	3.13	1.25	0.72	2.75	1.00	1.38	3.44	1.38	2.75	2.00	1.38	4.81	2.00	4.13	2.13
HD625	2.94	1.63	1 1/4-12	1.45	3.13	1.25	0.72	2.75	1.00	1.38	3.44	1.38	2.75	2.00	1.38	4.81	2.00	4.13	2.13
HD740	5.63	3.00	2-12	2.25	5.00	2.00	1.09	5.00	2.00	1.75	5.00	4	2.00	2.50	2.50	7.00	3.00	8.00	4.5

# ORDERING GUIDE FOR THE ELIMINATOR HD ACTUATOR

## Ordering Information

<b>H</b>	<b>D</b>				-			-			-			-					-	
----------	----------	--	--	--	---	--	--	---	--	--	---	--	--	---	--	--	--	--	---	--

<b>Base No. (Capacity)</b> <b>HD201</b> (1,000 lbf) <b>HD302</b> (2,000 lbf) <b>HD304</b> (4,000 lbf) <b>HD404</b> (4,000 lbf) <b>HD406</b> (6,000 lbf) <b>HD508</b> (8,000 lbf) <b>HD516</b> (16,000 lbf) <b>HD618</b> (18,000 lbf) <b>HD625</b> (25,000 lbf) <b>HD740</b> (40,000 lbf)	<b>Unit Mounting Option</b> <b>MB:</b> Bottom Mount <b>FF:</b> Front Flange <b>MF:</b> Foot Mount <b>TF:</b> Front Trunnion <b>TR:</b> Rear Trunnion	<b>Motor Position</b> 1, 2, 3, 4 0 = In-Line 	<b>Precision/Lead Accuracy**</b> <b>A:</b> .002 in/ft Zero Backlash <b>B:</b> .0005 in/ft Zero Backlash <b>X:</b> Standard
<b>Std. Stroke Length*</b> <b>06:</b> 6 in. <b>12:</b> 12 in. <b>18:</b> 18 in. <b>24:</b> 24 in. <b>30:</b> 30 in. <b>36:</b> 36 in. <b>42:</b> 42 in. <b>48:</b> 48 in.	<b>Rod End Option</b> <b>E:</b> Female Eye <b>F:</b> Female Thread <b>A:</b> Self-Aligning Coupler <b>M:</b> Male Thread <b>S:</b> Spherical Rod Eye	<b>Gearbelt Reduction</b> <b>00:</b> In-Line/Direct Coupled <b>10:</b> 1:1 <b>20:</b> 2:1	<b>N.C. Switch Qty</b> 0, 1, 2, 3, etc.
	<b>Configuration</b> <b>L:</b> In-Line <b>U:</b> Parallel Offset	<b>Switch Type</b> <b>A:</b> Hall Sourcing PNP <b>B:</b> Hall Sinking NPN <b>C:</b> Reed <b>D:</b> Switch Track / No Switches <b>X:</b> Solid Cover / No Switches	<b>N.O. Switch Qty</b> 0, 1, 2, 3, etc.

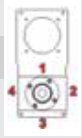
For custom stroke lengths, contact Joyce/Dayton.

\* HD201 is available with stroke lengths up to 12 in.  
 HD302 – HD304 are available with stroke lengths up to 36 in.  
 HD404 – HD406 are available with stroke lengths up to 42 in.  
 HD508 – HD740 are available with stroke lengths up to 48 in.  
 \*\* HD201 – Std. Precision/Lead Accuracy is 0.0005 in/ft, Zero Backlash  
 \*\* HD302, HD404 – Zero Backlash not available  
 \*\*\* HD618, HD625 – Contact Joyce/Dayton for Front Trunnion

# Eliminator HDL™ Actuator

## ELIMINATOR HD + INTEGRATED LOAD CELL

The Eliminator HDL combines all the precision features of the HD series with the additional benefit of an integrated load cell, providing continuous and accurate measurement of applied loads and force. This heavy-duty, rugged linear actuator provides a clean, simple, and economical solution for your high-speed precision thrust applications.

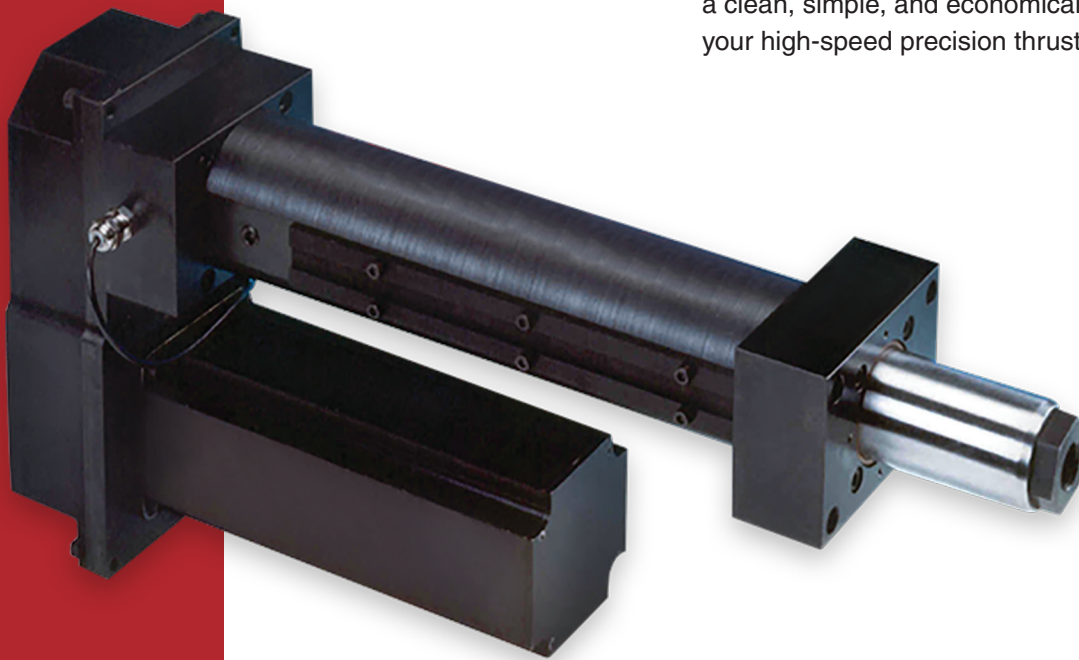

### *Ideal for a Variety of Applications Including:*

- Process Monitoring
- Prototyping
- Force Control
- Hydraulic Replacement
- And More

### Key Features:

- “Measure while you press” integrated load cell design
- Conforms to latest standard ASTM E4 for testing machines
- Rated forces up to 40,000 lbf
- High velocity up to 20 in/sec, stroke up to 48 inches
- Accurate to within 0.5% of rated force
- 0.002 in/ft standard lead accuracy, 0.0005 in/ft optional lead accuracy
- Standard backlash is 0.003 in maximum

# SPECIFICATION CHART FOR THE ELIMINATOR HDL ACTUATOR

Model Number	Thrust Load Rated	Linear Velocity Max. <sup>1</sup>	Travel Length Max. <sup>2</sup>	Frame Size	Lead	Ball Screw Diameter	Ball Screw Max. <sup>1</sup>	Torque @ Ball Screw Max.	Dynamic Capacity Per Million Revs	Dynamic Capacity Per Million Inches	Motor Gearhead Frame Supported Max. <sup>2</sup>
	lbr	in/s	in	in	mm	mm	RPM	in-lb	lbr	lbr	in
HDL201	1,000	8.0	12	2.00	4	16	3,048	28	1,529	825	2.75
HDL302	2,000	20.0	36	3.00	10	25	3,048	139	6,490	4,760	4.25
HDL304	4,000	20.0	36	3.00	10	25	3,048	278	6,490	4,760	4.25
HDL404	4,000	18.0	42	4.00	10	32	2,743	278	14,580	10,690	5.75
HDL406	6,000	18.0	42	4.00	10	32	2,743	418	14,580	10,690	5.75
HDL508	8,000	14.0	48	5.00	12	50	1,778	668	31,250	24,340	8.00
HDL516	16,000	14.0	48	5.00	12	50	1,778	1,337	31,250	24,340	8.00
HDL618	18,000	9.8	48	6.00	12	63	1,245	1,504	35,750	27,840	8.00
HDL625	25,000	14.4	48	6.00	20	80	1,097	3,481	52,150	48,160	8.00
HDL740	40,000	14.4	48	7.00	20	80	1,097	5,575	52,150	48,160	10.85

Model Number	Inertia 1:1 Zero Stroke <sup>3</sup>	Inertia 1:1 Per Inch of Stroke <sup>3</sup>	Inertia 2:1 Zero Stroke <sup>3</sup>	Inertia 2:1 Per Inch of Stroke <sup>3</sup>	Inertia Inline Zero Stroke <sup>3</sup>	Inertia Inline Per Inch of Stroke <sup>3</sup>	Unit Weight "U" Motor Mount <sup>4</sup>	Unit Weight "L" Motor Mount <sup>4</sup>	Weight Per Inch of Stroke <sup>4</sup>
	lb-in <sup>2</sup>	lb-in <sup>2</sup>	lb-in <sup>2</sup>	lb-in <sup>2</sup>	lb-in <sup>2</sup>	lb-in <sup>2</sup>	lb	lb	lb
HDL201	0.51	0.0031	0.27	0.0008	0.04	0.0031	8	6	1
HDL302	4.31	0.0212	1.64	0.0053	0.34	0.0212	29	22	1
HDL304	4.87	0.0212	1.46	0.0053	0.38	0.0212	29	22	1
HDL404	23.24	0.0457	4.11	0.0114	1.99	0.0457	63	49	2
HDL406	23.24	0.0457	4.11	0.0114	1.99	0.0457	63	49	2
HDL508	139.27	0.2688	22.66	0.0672	5.92	0.2688	155	105	3
HDL516	139.36	0.2688	22.68	0.0672	6.00	0.2688	155	105	3
HDL618	281.96	0.7361	43.91	0.1840	12.31	0.7361	207	152	6
HDL625	295.02	1.8713	47.17	0.4678	25.37	1.8713	214	158	6
HDL740	401.85	1.8707	64.87	0.4677	96.29	1.8707	373	318	7.41

<sup>1</sup> Maximum velocity and maximum screw speed may not be achievable at maximum stroke.

<sup>2</sup> Larger Motor or Gearhead Frames and longer stroke lengths are available upon request.

<sup>3</sup> All inertia values are at the input shaft and are representative of typical pulleys, bushings, couplers, etc. Actual values may vary due to motor selection.

<sup>4</sup> Weight values are for reference only and vary depending on configuration.

"U" Parallel offset configuration

"L" Inline configuration

## DATA CURVES FOR THE ELIMINATOR HDL ACTUATOR

### Dynamic Capacity: Life Vs. Load

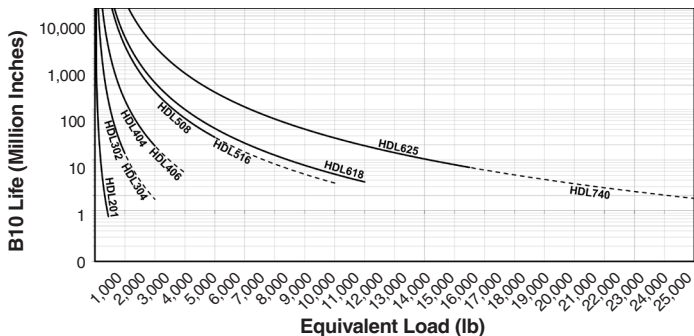

### Speed Vs. Stroke

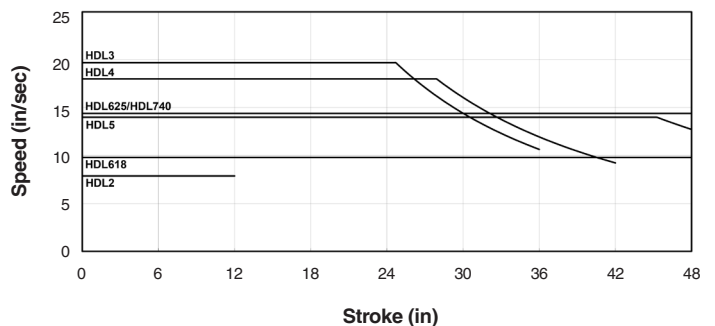

# DIMENSIONED DRAWINGS FOR THE ELIMINATOR HDL ACTUATOR

Dimensions are in inches and are subject to change without notice.

## U-Parallel Offset Motor Configuration

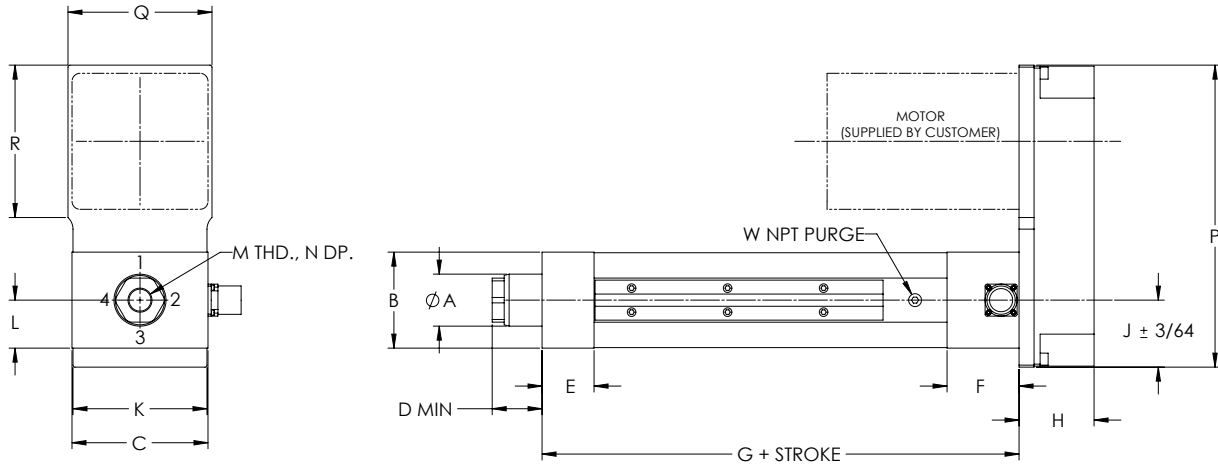

## L-Inline Motor Configuration

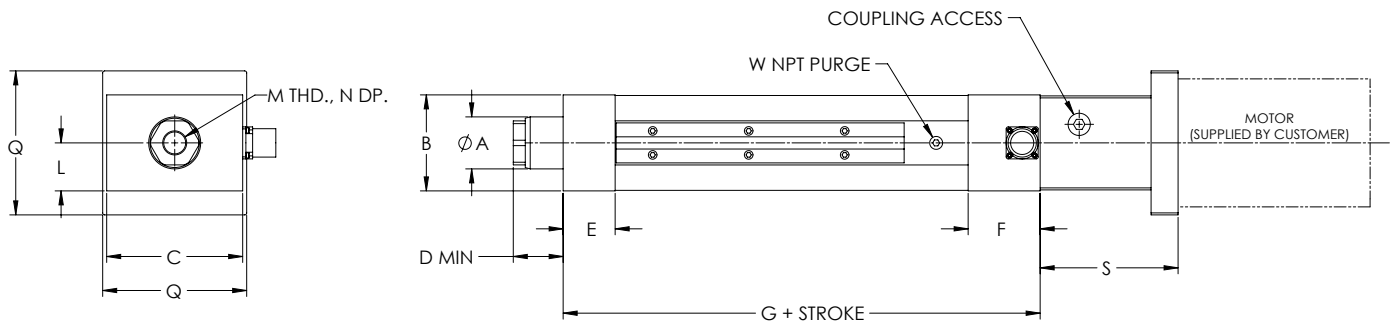

"S" length may vary depending on motor or gearbox.

## HDL U-Parallel Offset and L-Inline Motor Configuration

Model	A	B	C	D	E	F	G	H	J	K	L	M	N	P	Q	R	S	W
HDL201	1.13	2.00	3.00	1.04	1.00	1.75	6.34	1.63	1.48	2.97	1.00	1/2-20	1.00	6.30	2.97	N/A	2.66	1/8
HDL302	1.63	3.00	4.25	1.41	1.63	2.25	8.91	2.34	2.09	4.19	1.50	3/4-16	1.00	9.44	4.50	4.75	4.31	1/8
HDL304	1.63	3.00	4.25	1.56	1.63	2.25	8.91	2.34	2.09	4.19	1.50	3/4-16	1.00	9.44	4.50	4.75	4.31	1/8
HDL404	2.25	4.00	5.50	1.88	2.00	2.63	10.22	2.63	2.69	5.38	2.00	3/4-16	1.00	13.00	6.00	6.94	5.00	1/4
HDL406	2.25	4.00	5.50	1.79	2.00	2.63	10.22	2.63	2.69	5.38	2.00	3/4-16	1.00	13.00	6.00	6.94	5.00	1/4
HDL508	3.00	5.00	7.75	2.56	2.50	3.00	13.38	4.03	3.81	7.63	2.50	1 1/4-12	1.63	17.19	8.38	9.19	6.75	3/8
HDL516	3.00	5.00	7.75	2.56	2.50	3.00	14.38	4.03	3.81	7.63	2.50	1 1/4-12	1.63	17.19	8.38	9.19	6.75	3/8
HDL618	3.50	6.00	8.50	2.75	3.00	4.00	15.00	4.13	4.13	8.38	3.00	1 1/4-12	1.63	17.88	9.00	9.19	7.25	1/2
HDL625	4.00	6.00	8.50	2.75	3.00	4.00	17.75	4.13	4.13	8.38	3.00	1 1/4-12	1.63	17.88	9.00	9.19	7.25	1/2
HDL740	4.25	7.00	10.00	3.77	3.50	5.56	20.02	5.44	4.94	9.88	3.50	2-12	3.00	19.88	10.94	10.05	10.17	1/2

# DIMENSIONED DRAWINGS FOR THE ELIMINATOR HDL ACTUATOR

Dimensions are in inches and are subject to change without notice.

## Bottom Mount Dimensions

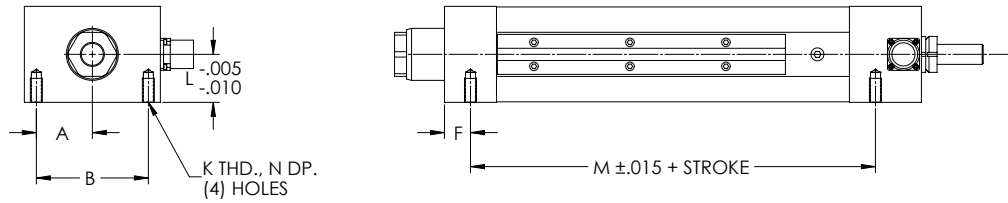

## Front Flange Dimensions

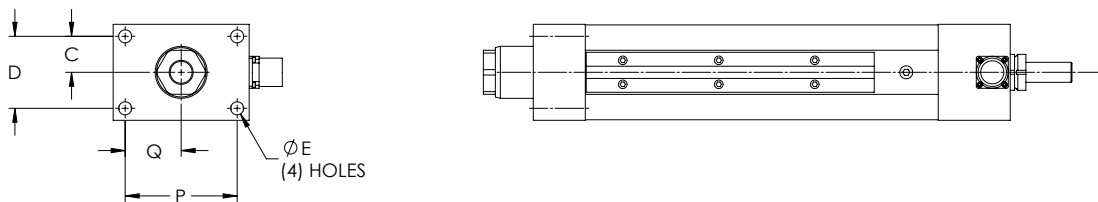

## Foot Mount Dimensions

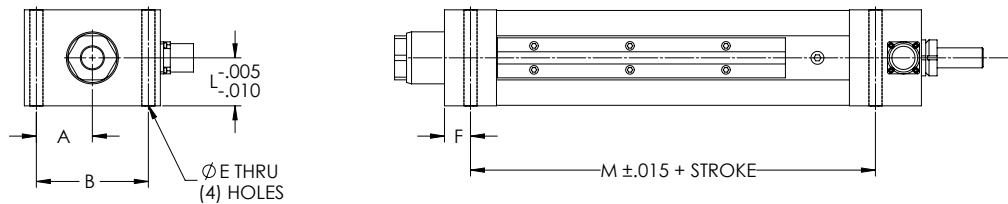

## Trunnion Mount Dimensions

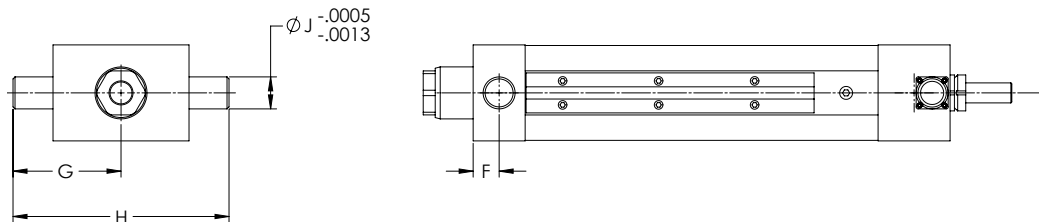

## HDL Mounting Dimensions (Bottom Mount, Front Flange, Foot Mount, Trunnion Mount)

Model	A	B	C	D	E	F	G	H	J	K	L	M	N	P	Q
HDL201	1.13	2.25	0.69	1.38	0.34	0.49	2.24	4.48	0.50	5/16-18	0.99	4.63	0.63	2.38	1.19
HDL302	1.75	3.50	1.13	2.25	0.41	0.81	3.38	6.75	1.00	3/8-16	1.50	6.66	0.75	3.50	1.75
HDL304	1.75	3.50	1.13	2.25	0.41	0.81	3.38	6.75	1.00	3/8-16	1.50	6.66	0.75	3.50	1.75
HDL404	2.19	4.38	1.44	2.88	0.69	1.00	4.50	9.00	1.25	5/8-11	2.00	7.59	1.00	4.38	2.19
HDL406	2.19	4.38	1.44	2.88	0.69	1.00	4.50	9.00	1.25	5/8-11	2.00	7.59	1.00	4.38	2.19
HDL508	3.13	6.25	1.75	3.50	0.81	1.25	6.25	12.50	1.50	3/4-10	2.50	10.63	1.25	6.25	3.13
HDL516	3.13	6.25	1.75	3.50	0.81	1.25	6.25	12.50	1.50	3/4-10	2.50	10.63	1.25	6.25	3.13
HDL618	3.31	6.63	2.00	4.00	1.06		Contact Joyce/Dayton			1-8	3.00	11.00	1.63	6.63	3.31
HDL625	3.31	6.63	2.00	4.00	1.06		Contact Joyce/Dayton			1-8	3.00	13.75	1.63	6.63	3.31
HDL740	4.00	8.00	2.50	5.00	1.06	1.75	7.88	15.75	2.00	1-8	3.50	14.96	2.00	8.00	4.00

# DIMENSIONED DRAWINGS FOR THE ELIMINATOR HDL ACTUATOR

Dimensions are in inches and are subject to change without notice.

## Rod End Options

### Self-Aligning Coupler

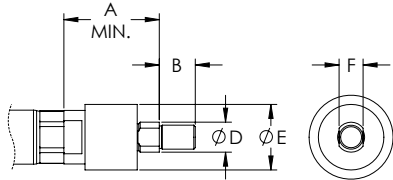

### Male Thread

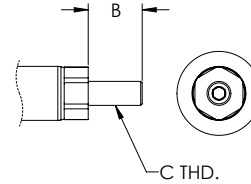

### Spherical Rod Eye

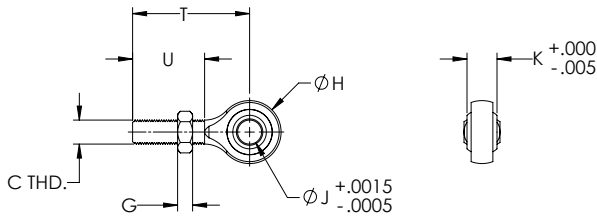

### Female Eye

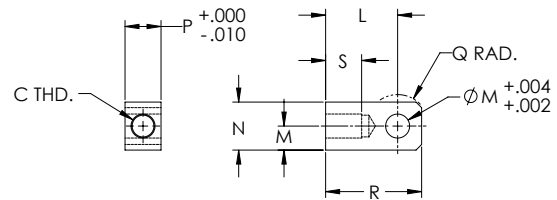

## HDL Rod End Dimensions

Model	A	B	C	D	E	F	G	H	J	K	L	M	N	P	Q	R	S	T	U
HDL201	2.00	0.75	1/2-20	0.63	1.37	0.50	0.31	1.31	0.50	0.63	1.50	0.50	1.00	0.75	0.50	2.00	0.75	2.44	1.50
HDL302	2.31	1.13	3/4-16	0.97	2.00	0.75	0.42	1.75	0.75	0.88	2.06	0.75	1.50	1.25	0.75	2.81	1.13	2.88	1.75
HDL304	2.31	1.13	3/4-16	0.97	2.00	0.75	0.42	1.75	0.75	0.88	2.06	0.75	1.50	1.25	0.75	2.81	1.13	2.88	1.75
HDL404	2.31	1.13	3/4-16	0.97	2.00	0.75	0.42	1.75	0.75	0.88	2.06	0.75	1.50	1.25	0.75	2.81	1.13	2.88	1.75
HDL406	2.31	1.13	3/4-16	0.97	2.00	0.75	0.42	1.75	0.75	0.88	2.06	0.75	1.50	1.25	0.75	2.81	1.13	2.88	1.75
HDL508	2.94	1.63	1 1/4-12	1.45	3.13	1.25	0.72	2.75	1.00	1.38	3.44	1.38	2.75	2.00	1.38	4.81	2.00	4.13	2.13
HDL516	2.94	1.63	1 1/4-12	1.45	3.13	1.25	0.72	2.75	1.00	1.38	3.44	1.38	2.75	2.00	1.38	4.81	2.00	4.13	2.13
HDL618	2.94	1.63	1 1/4-12	1.45	3.13	1.25	0.72	2.75	1.00	1.38	3.44	1.38	2.75	2.00	1.38	4.81	2.00	4.13	2.13
HDL625	2.94	1.63	1 1/4-12	1.45	3.13	1.25	0.72	2.75	1.00	1.38	3.44	1.38	2.75	2.00	1.38	4.81	2.00	4.13	2.13

# ORDERING GUIDE FOR THE ELIMINATOR HDL ACTUATOR

## Ordering Information

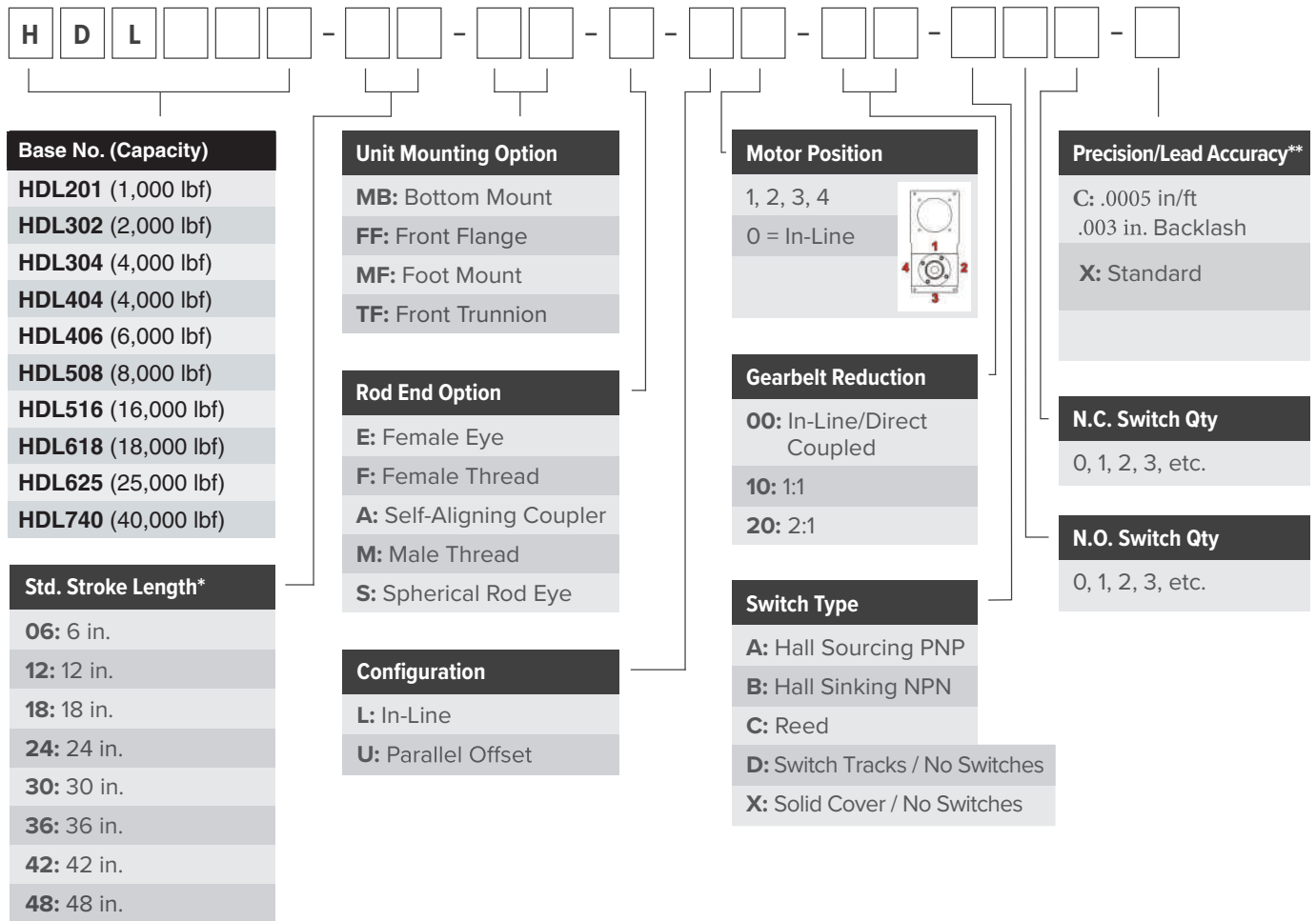

For custom stroke lengths, contact Joyce/Dayton.

\* HDL201 is available with stroke lengths up to 12 in.  
 HDL302 – HDL304 are available with stroke lengths up to 36 in.  
 HDL404 – HDL406 are available with stroke lengths up to 42 in.  
 HDL508 – HDL740 are available with stroke lengths up to 48 in.  
 \*\* HDL201 – Std. Precision/Lead Accuracy is 0.0005 in/ft, 0.003 in. Backlash

# Eliminator SP™ Actuator

## IP69K STAINLESS STEEL, HEAVY DUTY, HIGH SPEED, HIGH FORCE

The Eliminator SP and SPL series Heavy Duty linear actuators offer all the performance advantages of our HD actuator, now with IP69K rating. Ideal for food and medical grade applications, this 316 stainless steel actuator is designed for high-pressure and high-temperature washdown conditions.



### *Ideal for a Variety of Applications Including:*

- Food Processing
- Volumetric Filling / Pumping
- Medical Equipment
- Pressing / Punching
- Hydraulic Replacement
- And More

### Key Features:

## IP69K

- IP69K rated for high-pressure, high-temperature washdown
- Contoured 316 stainless steel construction with hard chrome plated piston rod
- Durable anti-rotation feature
- Rated thrust up to 25,000 lbf
- Velocity to 20 in/sec, stroke up to 48 inches
- Integrated load cell option provides continuous bi-directional measurement of applied loads (SPL model)
- 0.002 in/ft standard lead accuracy, with 0.0005 in/ft option
- Standard backlash is 0.003 in maximum; optional zero backlash is also available

# SPECIFICATION CHART FOR THE ELIMINATOR SP ACTUATOR

Model Number	Thrust Load Rated	Linear Velocity Max. <sup>1</sup>	Travel Length Max. <sup>2</sup>	Frame Size	Lead	Ball Screw Diameter	Ball Screw Max. <sup>1</sup>	Torque @ Ball Screw Max.	Dynamic Capacity Per Million Revs	Dynamic Capacity Per Million Inches	Motor Gearhead Frame Supported Max. <sup>2</sup>
	lb <sub>r</sub>	in/s	in	in	mm	mm	RPM	in-lb	lb <sub>r</sub>	lb <sub>r</sub>	in
SP201	1,000	8.0	12	2	4	16	3,048	28	1,529	825	2.75
SP302	2,000	20.0	36	3	10	25	3,048	139	6,490	4,760	4.25
SP304	4,000	20.0	36	3	10	25	3,048	278	6,490	4,760	4.25
SP404	4,000	18.0	42	4	10	32	2,743	278	14,580	10,690	5.75
SP406	6,000	18.0	42	4	10	32	2,743	418	14,580	10,690	5.75
SP508	8,000	14.0	48	5	12	50	1,778	668	31,250	24,340	8
SP516	16,000	14.0	48	5	12	50	1,778	1,337	31,250	24,340	8
SP618	18,000	9.8	48	6	12	63	1,245	1,504	35,750	27,840	8
SP625	25,000	14.4	48	6	20	80	1,097	3,481	52,150	48,160	8

Model Number	Inertia 1:1 Zero Stroke <sup>3</sup>	Inertia 1:1 Per Inch of Stroke <sup>3</sup>	Inertia 2:1 Zero Stroke <sup>3</sup>	Inertia 2:1 Per Inch of Stroke <sup>3</sup>	Inertia Inline Zero Stroke <sup>3</sup>	Inertia Inline Per Inch of Stroke <sup>3</sup>	Unit Weight "U" Motor Mount <sup>4</sup>	Unit Weight "L" Motor Mount <sup>4</sup>	Weight Per Inch of Stroke <sup>4</sup>
	lb-in <sup>2</sup>	lb-in <sup>2</sup>	lb-in <sup>2</sup>	lb-in <sup>2</sup>	lb-in <sup>2</sup>	lb-in <sup>2</sup>	lb	lb	lb
SP201	0.51	0.0031	0.27	0.0008	0.04	0.0031	9	7	0.96
SP302	4.31	0.0212	1.64	0.0053	0.34	0.0212	43	70	2.13
SP304	4.87	0.0212	1.46	0.0053	0.38	0.0212	43	70	2.13
SP404	23.24	0.0457	4.11	0.0114	1.99	0.0457	76	70	2.73
SP406	23.24	0.0457	4.11	0.0114	1.99	0.0457	76	70	2.73
SP508	139.27	0.2688	22.66	0.0672	5.92	0.2688	179	145	4.99
SP516	139.36	0.2688	22.68	0.0672	6.00	0.2688	179	145	4.99
SP618	281.96	0.7361	43.91	0.1840	12.31	0.7361	216	181	6.21
SP625	295.02	1.8713	47.17	0.4678	25.37	1.8713	282	248	6.62

<sup>1</sup> Maximum velocity and maximum screw speed may not be achievable at maximum stroke.

<sup>2</sup> Larger Motor or Gearhead Frames and longer stroke lengths are available upon request.

<sup>3</sup> All inertia values are at the input shaft and are representative of typical pulleys, bushings, couplers, etc. Actual values may vary due to motor selection.

<sup>4</sup> Weight values are for reference only and vary depending on configuration.

\*IP69K rating for static only.

## DATA CURVES FOR THE ELIMINATOR SP ACTUATOR

### Dynamic Capacity: Life Vs. Load

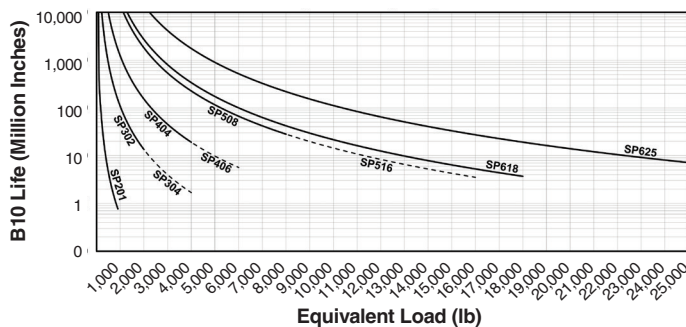

### Speed Vs. Stroke

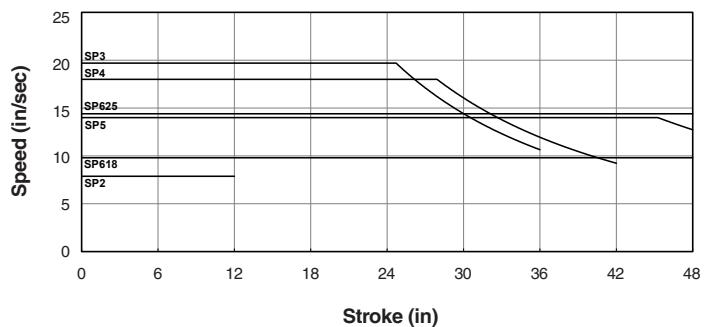

# DIMENSIONED DRAWINGS FOR THE ELIMINATOR SP ACTUATOR

Dimensions are in inches and are subject to change without notice.

## U-Parallel Offset Motor Configuration

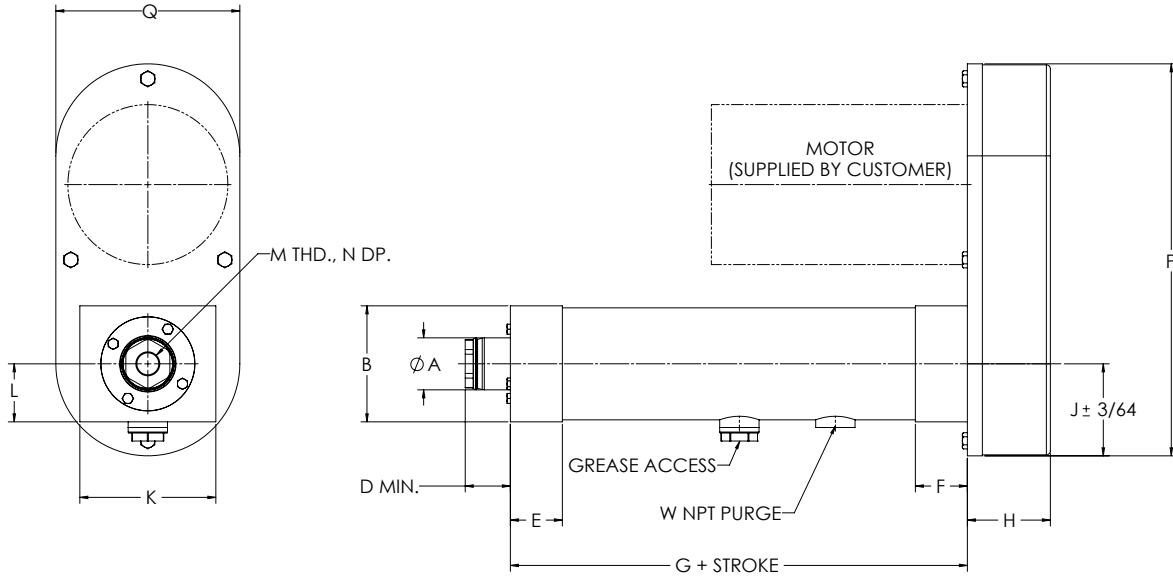

## L-Inline Motor Configuration

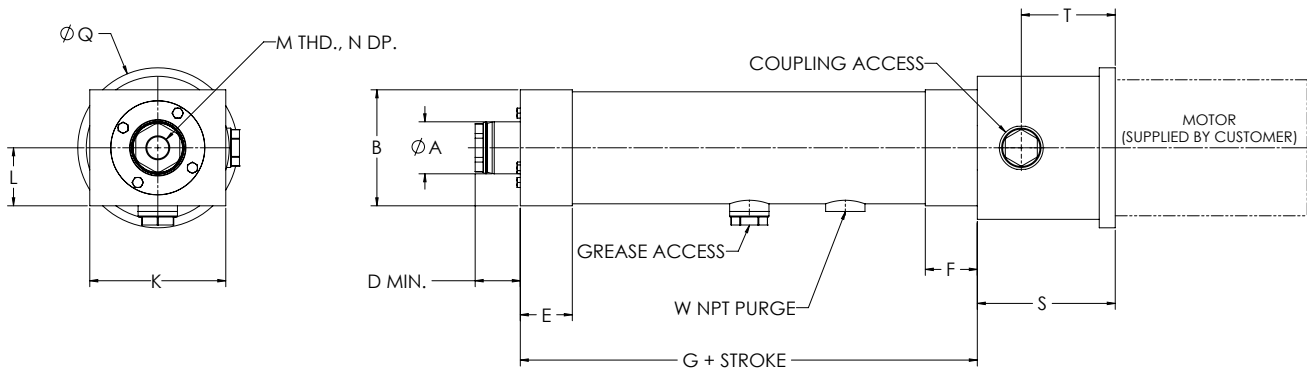

"S" length may vary depending on motor or gearbox.

## SP U-Parallel Offset and L-Inline Motor Configuration

Model	A	B	C	D	E	F	G	H	J	K	L	M	N	P	Q	S	W
SP201	1.13	2.28	3.00	1.04	1.00	1.00	5.63	1.88	2.25	4.50	1.14	1/2-20	1.00	8.50	4.50	2.94	1/8
SP302	1.63	3.63	4.25	1.41	1.63	1.63	8.28	2.59	3.20	5.75	1.81	3/4-16	1.00	12.25	5.75	4.31	1/8
SP304	1.63	3.63	4.25	1.56	1.63	1.63	8.28	2.59	3.20	5.75	1.81	3/4-16	1.00	12.25	5.75	4.31	1/8
SP404	2.25	4.38	5.50	1.88	2.00	2.00	9.59	2.72	3.50	7.19	2.19	3/4-16	1.00	10.96	7.19	5.25	1/4
SP406	2.25	4.38	5.50	1.79	2.00	2.00	9.59	2.72	3.50	7.19	2.19	3/4-16	1.00	10.96	7.19	5.25	1/4
SP508	3.00	5.63	7.75	2.56	2.50	3.00	13.38	4.50	4.61	9.00	3.88	1 1/4-12	1.63	17.25	9.00	6.75	3/8
SP516	3.00	5.63	7.75	2.56	2.50	3.00	13.38	4.50	4.61	9.00	3.88	1 1/4-12	1.63	17.25	9.00	6.75	3/8
SP618	3.50	6.13	8.50	2.75	3.00	3.00	14.00	4.68	5.84	11.00	3.06	1 1/4-12	1.63	19.50	11.00	7.25	1/2
SP625	Contact Joyce/Dayton																

# DIMENSIONED DRAWINGS FOR THE ELIMINATOR SP ACTUATOR

Dimensions are in inches and are subject to change without notice.

## Bottom Mount Dimensions

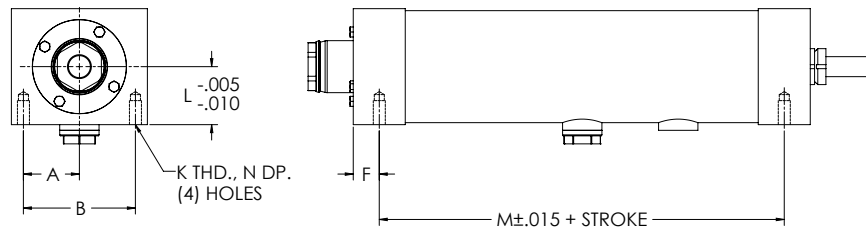

## Front Flange Dimensions

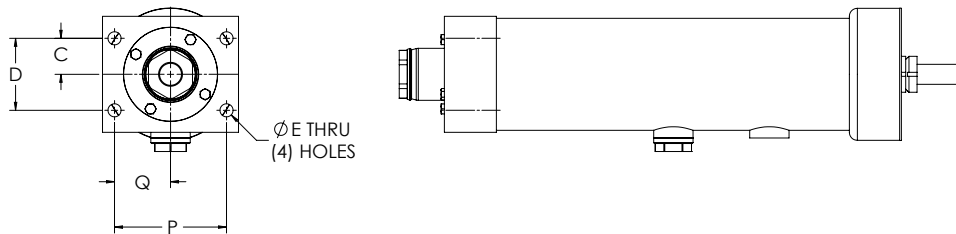

## Foot Mount Dimensions

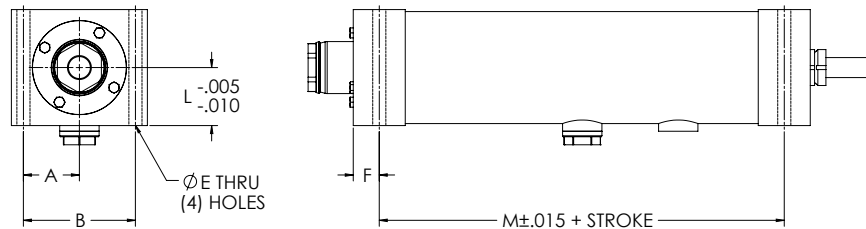

## Trunnion Mount Dimensions

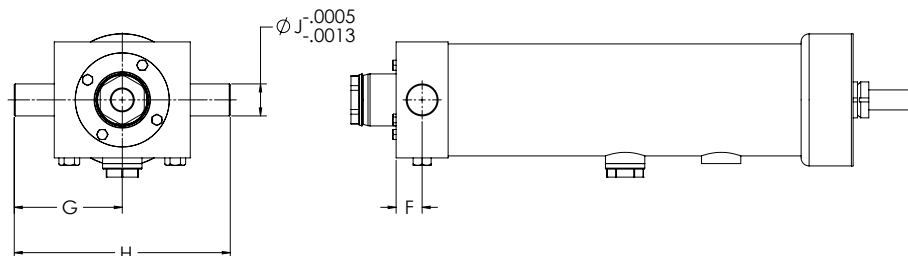

## SP Mounting Dimensions (Bottom Mount, Front Flange, Foot Mount, Trunnion Mount)

Model	A	B	C	D	E	F	G	H	J	K	L	M	N	P	Q
SP201	1.13	2.25	0.69	1.38	0.34	0.49	2.25	4.50	0.50	5/16-18	1.14	4.63	0.63	2.38	1.19
SP302	1.75	3.50	1.13	2.25	0.41	0.81	3.38	6.75	1.00	3/8-16	1.81	6.66	0.75	3.50	1.75
SP304	1.75	3.50	1.13	2.25	0.41	0.81	3.38	6.75	1.00	3/8-16	1.81	6.66	0.75	3.50	1.75
SP404	2.19	4.38	1.44	2.88	0.69	1.00	4.50	9.00	1.25	5/8-11	2.19	7.59	1.00	4.38	2.19
SP406	2.19	4.38	1.44	2.88	0.69	1.00	4.50	9.00	1.25	5/8-11	2.19	7.59	1.00	4.38	2.19
SP508	3.13	6.25	1.75	3.50	0.81	1.25	6.25	12.50	1.50	3/4-10	3.88	10.63	1.25	6.25	3.13
SP516	3.13	6.25	1.75	3.50	0.81	1.25	6.25	12.50	1.50	3/4-10	3.88	10.63	1.25	6.25	3.13
SP618	3.31	6.63	2.00	4.00	1.06	Contact Joyce/Dayton				1-8	3.06	11.00	1.63	6.63	3.31
SP625	Contact Joyce/Dayton														

# DIMENSIONED DRAWINGS FOR THE ELIMINATOR SP ACTUATOR

Dimensions are in inches and are subject to change without notice.

## Rod End Options

### Self-Aligning Coupler

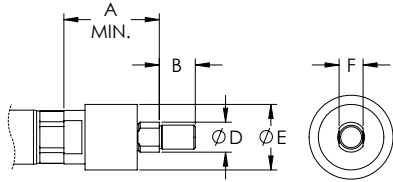

### Male Thread

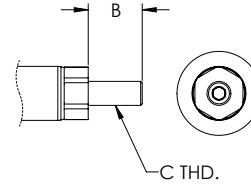

### Spherical Rod Eye

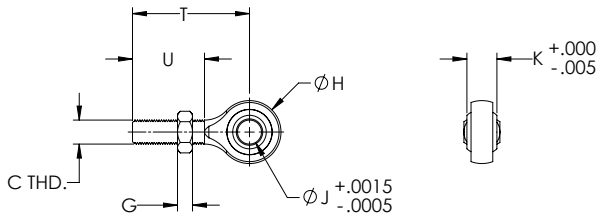

### Female Eye

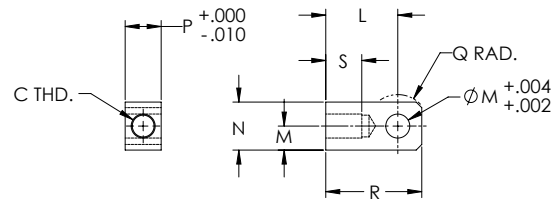

## SP Rod End Dimensions

Model	A	B	C	D	E	F	G	H	J	K	L	M	N	P	Q	R	S	T	U
SP201	2.00	0.75	1/2-20	0.63	1.37	0.50	0.31	1.31	0.50	0.63	1.50	0.50	1.00	0.75	0.63	2.00	0.75	2.44	1.50
SP302	2.38	1.13	3/4-16	0.97	1.75	0.88	0.42	1.75	0.75	0.88	2.06	0.75	1.50	1.25	0.88	2.81	1.13	2.88	1.75
SP304	2.38	1.13	3/4-16	0.97	1.75	0.88	0.42	1.75	0.75	0.88	2.06	0.75	1.50	1.25	0.88	2.81	1.13	2.88	1.75
SP404	2.38	1.13	3/4-16	0.97	1.75	0.88	0.42	1.75	0.75	0.88	2.06	0.75	1.50	1.25	0.88	2.81	1.13	2.88	1.75
SP406	2.38	1.13	3/4-16	0.97	1.75	0.88	0.42	1.75	0.75	0.88	2.06	0.75	1.50	1.25	0.88	2.81	1.13	2.88	1.75
SP508	2.94	1.63	1 1/4-12	1.38	2.50	1.25	0.72	2.75	1.00	1.38	3.44	1.38	2.75	2.00	1.56	4.81	2.00	4.13	2.13
SP516	2.94	1.63	1 1/4-12	1.38	2.50	1.25	0.72	2.75	1.00	1.38	3.44	1.38	2.75	2.00	1.56	4.81	2.00	4.13	2.13
SP618	2.94	1.63	1 1/4-12	1.38	2.50	1.25	0.72	2.75	1.00	1.38	3.44	1.38	2.75	2.00	1.56	4.81	2.00	4.13	2.13
SP625	Contact Joyce/Dayton																		

# ORDERING GUIDE FOR THE ELIMINATOR SP ACTUATOR

## Ordering Information

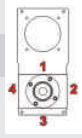
<b>S</b>	<b>P</b>				-			-			-			-				-	
<b>Base No. (Capacity)</b>					<b>Unit Mounting Option</b>					<b>Motor Position</b>					<b>Precision/Lead Accuracy***</b>				
SP201 (1,000 lbf)					MB: Bottom Mount					1, 2, 3, 4					A: .002 in/ft Zero Backlash				
SP302 (2,000 lbf)					FF: Front Flange					0 = In-Line					B: .0005 in/ft Zero Backlash				
SP304 (4,000 lbf)					MF: Foot Mount										X: Standard				
SP404 (4,000 lbf)					TF: Front Trunnion										<b>Gearbelt Reduction</b>				
SP406 (6,000 lbf)					<b>Rod End Option ****</b>					00: In-Line/Direct Coupled					<b>N.C. Switch Qty ****</b>				
SP508 (8,000 lbf)					E: Female Eye					10: 1:1					0, 1, 2, 3, etc.				
SP516 (16,000 lbf)					F: Female Thread					20: 2:1					<b>N.O. Switch Qty ****</b>				
SP618 (18,000 lbf)					A: Self-Aligning Coupler**					<b>Switch Type</b>					0, 1, 2, 3, etc.				
SP625 (25,000 lbf)					M: Male Thread					A: Hall Sourcing PNP									
<b>Std. Stroke Length*</b>					S: Spherical Rod Eye					B: Hall Sinking NPN									
06: 6 in.					<b>Configuration</b>					C: Reed									
12: 12 in.					L: In-Line					X: No Switches									
18: 18 in.					U: Parallel Offset														
24: 24 in.																			
30: 30 in.																			
36: 36 in.																			
42: 42 in.																			
48: 48 in.																			

For custom stroke lengths, contact Joyce/Dayton.

**\* Standard Stroke Lengths**

- SP201 stroke lengths up to 12 in.
- SP302 – SP304 stroke lengths up to 36 in.
- SP404 – SP406 stroke lengths up to 42 in.
- SP508 – SP740 stroke lengths up to 48 in.

**\*\* Self-Aligning Coupler**

Not available for SP625

**\*\*\* Precision/Lead Accuracy**

- SP201 – 0.0005 in/ft, Zero Backlash is standard
- SP302, SP404 – Zero Backlash not available

**\*\*\*\* IP69K Exceptions**

Self-Aligning Coupler and Spherical Rod Ends not rated  
Sealed Limit Switches, IP65 rated

# Eliminator SPL™ Actuator

## IP69K STAINLESS STEEL ACTUATOR + INTEGRATED LOAD CELL

The Eliminator SPL offers all of the performance advantages of our SP actuator, including an IP69K rating. Ideal for food and medical-grade high-pressure, high-temperature washdown applications. These actuators include an integrated load cell, providing continuous and accurate measurement of applied loads and force.



### *Ideal for a Variety of Applications Including:*

- Process Monitoring
- Prototyping
- Force Control
- Hydraulic Replacement
- And More

### Key Features:

## IP69K

- IP69K rated for high-pressure, high-temperature washdown
- “Measure while you Press” integrated load cell design
- Countoured 316 stainless steel construction with hard chrome plated piston rod
- Durable anti-rotation feature
- Loads and forces up to 25,000 lbf, High-velocity to 20 in/sec, stroke to 48 inches
- Accurate to within 0.5% of rated force
- 0.002 in/ft standard lead accuracy, 0.0005 in/ft optional lead accuracy
- Standard backlash is 0.003 in maximum

# SPECIFICATION CHART FOR THE ELIMINATOR SPL ACTUATOR

Model Number	Thrust Load Rated	Linear Velocity Max. <sup>1</sup>	Travel Length Max. <sup>2</sup>	Frame Size	Lead	Ball Screw Diameter	Ball Screw Max. <sup>1</sup>	Torque @ Ball Screw Max.	Dynamic Capacity Per Million Revs	Dynamic Capacity Per Million Inches	Motor Gearhead Frame Supported Max. <sup>2</sup>
	lbr	in/s	in	in	mm	mm	RPM	in-lb	lbr	lbr	in
SPL201	1,000	8.0	12	2	4	16	3,048	28	1,529	825	2.75
SPL302	2,000	20.0	36	3	10	25	3,048	139	6,490	4,760	4.25
SPL304	4,000	20.0	36	3	10	25	3,048	278	6,490	4,760	4.25
SPL404	4,000	18.0	42	4	10	32	2,743	278	14,580	10,690	5.75
SPL406	6,000	18.0	42	4	10	32	2,743	418	14,580	10,690	5.75
SPL508	8,000	14.0	48	5	12	50	1,778	668	31,250	24,340	8
SPL516	16,000	14.0	48	5	12	50	1,778	1,337	31,250	24,340	8
SPL618	18,000	9.8	48	6	12	63	1,245	1,504	35,750	27,840	8
SPL625	25,000	14.4	48	6	20	80	1,097	3,481	52,150	48,160	8

Model Number	Inertia 1:1 Zero Stroke <sup>3</sup>	Inertia 1:1 Per Inch of Stroke <sup>3</sup>	Inertia 2:1 Zero Stroke <sup>3</sup>	Inertia 2:1 Per Inch of Stroke <sup>3</sup>	Inertia Inline Zero Stroke <sup>3</sup>	Inertia Inline Per Inch of Stroke <sup>3</sup>	Unit Weight "U" Motor Mount <sup>4</sup>	Unit Weight "L" Motor Mount <sup>4</sup>	Weight Per Inch of Stroke <sup>4</sup>
	lb-in <sup>2</sup>	lb-in <sup>2</sup>	lb-in <sup>2</sup>	lb-in <sup>2</sup>	lb-in <sup>2</sup>	lb-in <sup>2</sup>	lb	lb	lb
SPL201	0.51	0.0031	0.27	0.0008	0.04	0.0031	9	7	0.96
SPL302	4.31	0.0212	1.64	0.0053	0.34	0.0212	43	70	2.13
SPL304	4.87	0.0212	1.46	0.0053	0.38	0.0212	43	70	2.13
SPL404	23.24	0.0457	4.11	0.0114	1.99	0.0457	76	70	2.73
SPL406	23.24	0.0457	4.11	0.0114	1.99	0.0457	76	70	2.73
SPL508	139.27	0.2688	22.66	0.0672	5.92	0.2688	179	145	4.99
SPL516	139.36	0.2688	22.68	0.0672	6.00	0.2688	179	145	4.99
SPL618	281.96	0.7361	43.91	0.1840	12.31	0.7361	216	181	6.21
SPL625	295.02	1.8713	47.17	0.4678	25.37	1.8713	282	248	6.62

<sup>1</sup> Maximum velocity and maximum screw speed may not be achievable at maximum stroke.

<sup>2</sup> Larger Motor or Gearhead Frames and longer stroke lengths are available upon request.

<sup>3</sup> All inertia values are at the input shaft and are representative of typical pulleys, bushings, couplers, etc. Actual values may vary due to motor selection.

<sup>4</sup> Weight values are for reference only and vary depending on configuration.

\*IP69K rating for static only.

"U" Parallel offset configuration

"L" Inline configuration

## DATA CURVES FOR THE ELIMINATOR SPL ACTUATOR

### Dynamic Capacity: Life Vs. Load

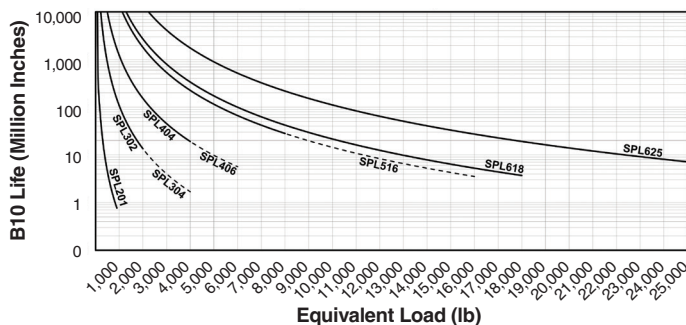

### Speed Vs. Stroke

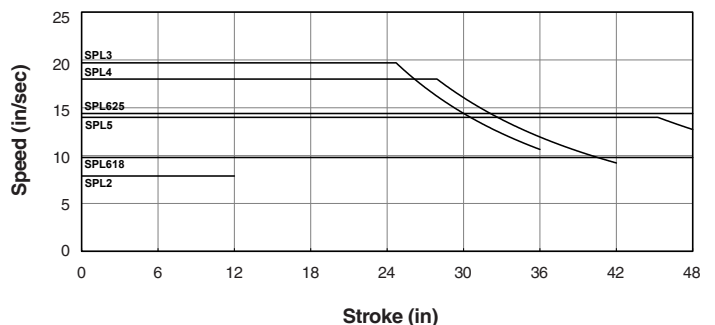

# DIMENSIONED DRAWINGS FOR THE ELIMINATOR SPL ACTUATOR

Dimensions are in inches and are subject to change without notice.

## U-Parallel Offset Motor Configuration

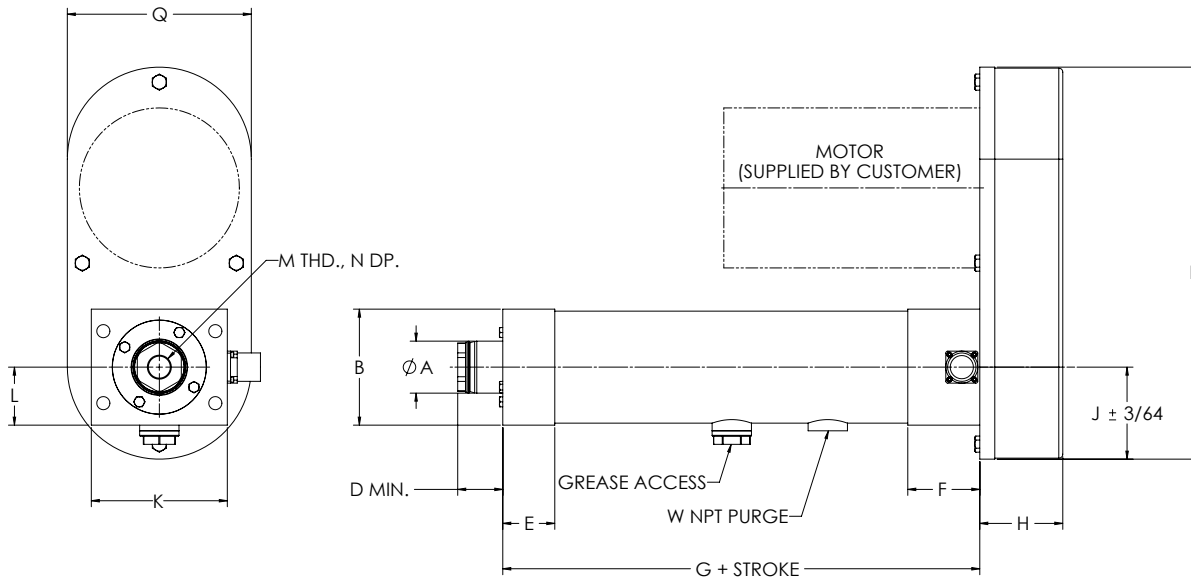

## L-Inline Motor Configuration

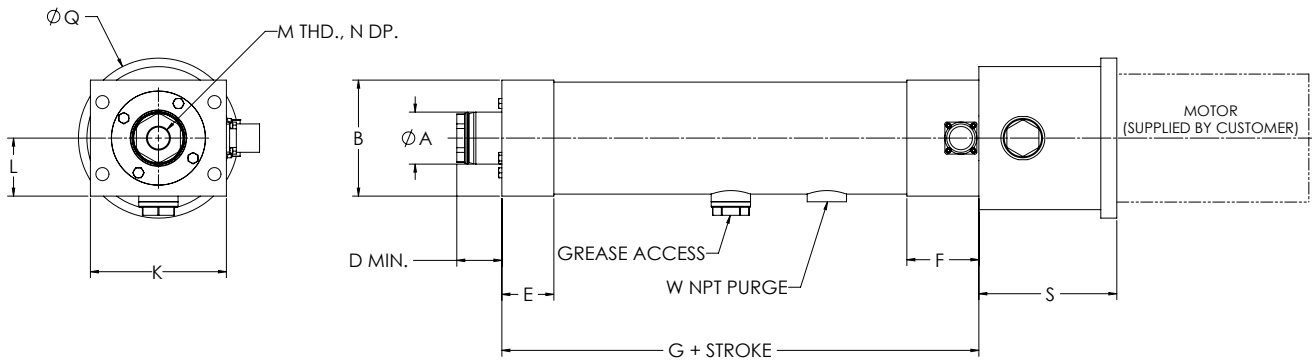

"S" length may vary depending on motor or gearbox.

## SPL U-Parallel Offset and L-Inline Motor Configuration

Model	A	B	C	D	E	F	G	H	J	K	L	M	N	P	Q	S	W
SPL201	1.13	2.28	3.00	1.04	1.00	1.00	6.38	1.88	2.25	4.50	1.14	1/2-20	1.00	8.50	4.50	2.94	1/8
SPL302	1.63	3.63	4.25	1.41	1.63	1.63	8.91	2.59	3.20	5.75	1.81	3/4-16	1.00	12.25	5.75	4.31	1/8
SPL304	1.63	3.63	4.25	1.56	1.63	1.63	8.91	2.59	3.20	5.75	1.81	3/4-16	1.00	12.25	5.75	4.31	1/8
SPL404	2.25	4.38	5.50	1.88	2.00	2.00	10.22	2.72	3.50	7.19	2.19	3/4-16	1.00	10.96	7.19	5.25	1/4
SPL406	2.25	4.38	5.50	1.79	2.00	2.00	10.22	2.72	3.50	7.19	2.19	3/4-16	1.00	10.96	7.19	5.25	1/4
SPL508	3.00	5.63	7.75	2.56	2.50	3.00	14.38	4.50	4.61	9.00	3.88	1 1/4-12	1.63	17.25	9.00	6.75	3/8
SPL516	3.00	5.63	7.75	2.56	2.50	3.00	14.38	4.50	4.61	9.00	3.88	1 1/4-12	1.63	17.25	9.00	6.75	3/8
SPL618	3.50	6.13	8.50	2.75	3.00	3.00	15.00	4.68	5.84	11.00	3.06	1 1/4-12	1.63	19.50	11.00	7.25	1/2
SPL625	Contact Joyce/Dayton																

# DIMENSIONED DRAWINGS FOR THE ELIMINATOR SPL ACTUATOR

Dimensions are in inches and are subject to change without notice.

## Bottom Mount Dimensions

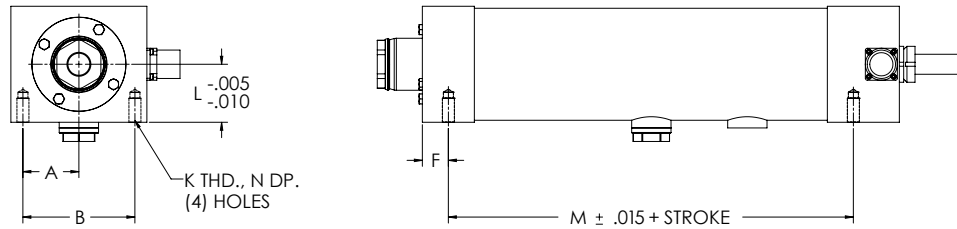

## Front Flange Dimensions

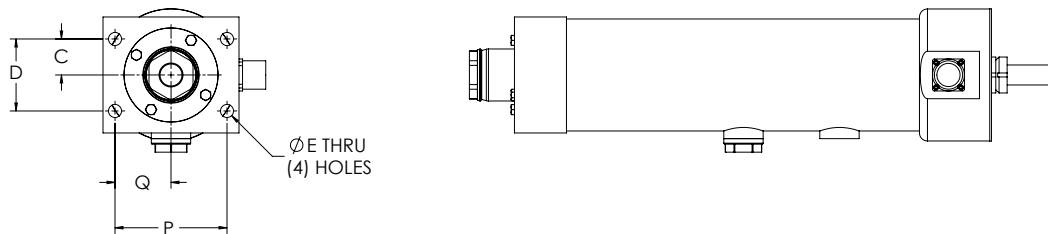

## Foot Mount Dimensions

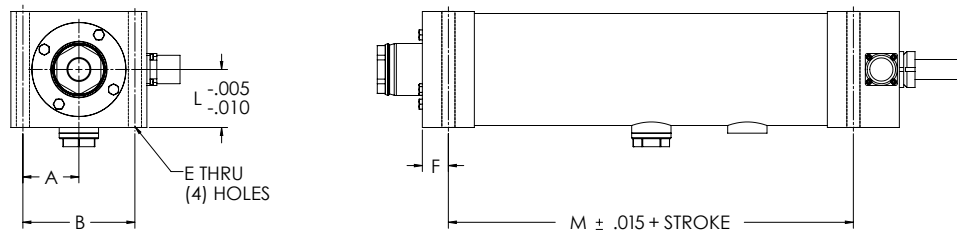

## Trunnion Mount Dimensions

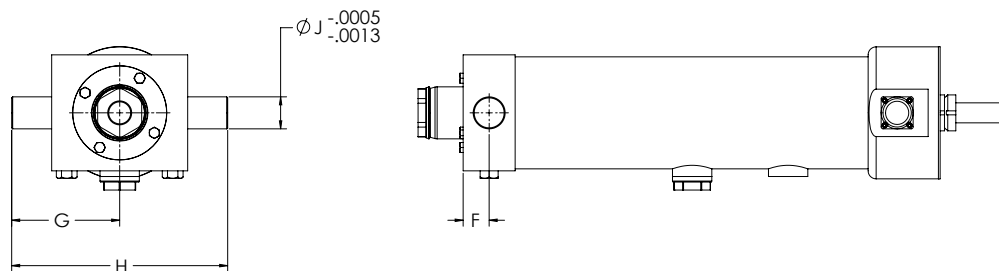

## SPL Mounting Dimensions (Bottom Mount, Front Flange, Foot Mount, Trunnion Mount)

Model	A	B	C	D	E	F	G	H	J	K	L	M	N	P	Q
SPL201	1.13	2.25	0.69	1.38	0.34	0.49	2.25	4.50	0.50	5/16-18	1.14	4.63	0.63	2.38	1.19
SPL302	1.75	3.50	1.13	2.25	0.41	0.81	3.38	6.75	1.00	3/8-16	1.81	6.66	0.75	3.50	1.75
SPL304	1.75	3.50	1.13	2.25	0.41	0.81	3.38	6.75	1.00	3/8-16	1.81	6.66	0.75	3.50	1.75
SPL404	2.19	4.38	1.44	2.88	0.69	1.00	4.50	9.00	1.25	5/8-11	2.19	7.59	1.00	4.38	2.19
SPL406	2.19	4.38	1.44	2.88	0.69	1.00	4.50	9.00	1.25	5/8-11	2.19	7.59	1.00	4.38	2.19
SPL508	3.13	6.25	1.75	3.50	0.81	1.25	6.25	12.50	1.50	3/4-10	3.88	10.63	1.25	6.25	3.13
SPL516	3.13	6.25	1.75	3.50	0.81	1.25	6.25	12.50	1.50	3/4-10	3.88	10.63	1.25	6.25	3.13
SPL618	3.31	6.63	2.00	4.00	1.06	Contact Joyce/Dayton				1-8	3.06	11.00	1.63	6.63	3.31
SPL625	Contact Joyce/Dayton														

# DIMENSIONED DRAWINGS FOR THE ELIMINATOR SPL ACTUATOR

Dimensions are in inches and are subject to change without notice.

## Rod End Options

### Self-Aligning Coupler

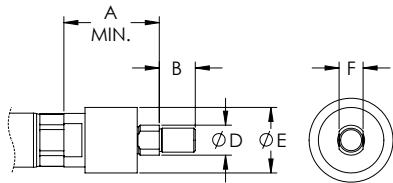

### Male Thread

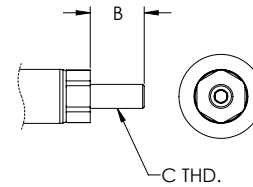

### Spherical Rod Eye

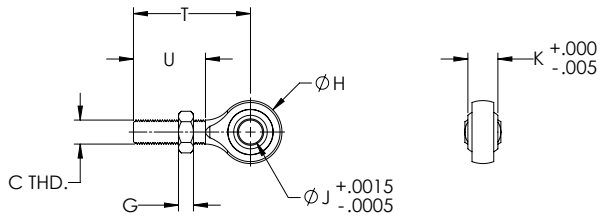

### Female Eye

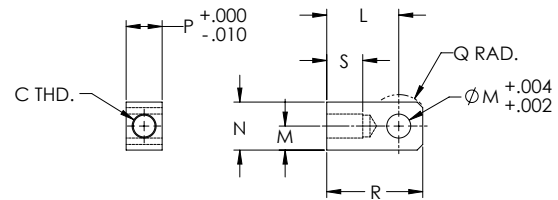

## SPL Rod End Dimensions

Model	A	B	C	D	E	F	G	H	J	K	L	M	N	P	Q	R	S	T	U
SPL201	2.00	0.75	1/2-20	0.63	1.37	0.50	0.31	1.31	0.50	0.63	1.50	0.50	1.00	0.75	0.63	2.00	0.75	2.44	1.50
SPL302	2.38	1.13	3/4-16	0.97	1.75	0.88	0.42	1.75	0.75	0.88	2.06	0.75	1.50	1.25	0.88	2.81	1.13	2.88	1.75
SPL304	2.38	1.13	3/4-16	0.97	1.75	0.88	0.42	1.75	0.75	0.88	2.06	0.75	1.50	1.25	0.88	2.81	1.13	2.88	1.75
SPL404	2.38	1.13	3/4-16	0.97	1.75	0.88	0.42	1.75	0.75	0.88	2.06	0.75	1.50	1.25	0.88	2.81	1.13	2.88	1.75
SPL406	2.38	1.13	3/4-16	0.97	1.75	0.88	0.42	1.75	0.75	0.88	2.06	0.75	1.50	1.25	0.88	2.81	1.13	2.88	1.75
SPL508	2.94	1.63	1 1/4-12	1.38	2.50	1.25	0.72	2.75	1.00	1.38	3.44	1.38	2.75	2.00	1.56	4.81	2.00	4.13	2.13
SPL516	2.94	1.63	1 1/4-12	1.38	2.50	1.25	0.72	2.75	1.00	1.38	3.44	1.38	2.75	2.00	1.56	4.81	2.00	4.13	2.13
SPL618	2.94	1.63	1 1/4-12	1.38	2.50	1.25	0.72	2.75	1.00	1.38	3.44	1.38	2.75	2.00	1.56	4.81	2.00	4.13	2.13
SPL625	Contact Joyce/Dayton																		



# Eliminator SS™ Actuator

## EXTREME SPEED CAPABILITY IN AN ELIMINATOR PLATFORM

The Eliminator SS Super Speed actuator is the linear solution for those automation applications demanding extremely high-speed motion. This combination of high thrust capacity, fast actuation, and precision motion are all provided in a strong, durable, actuator built on the Eliminator HD platform and adaptable to your servomotor.

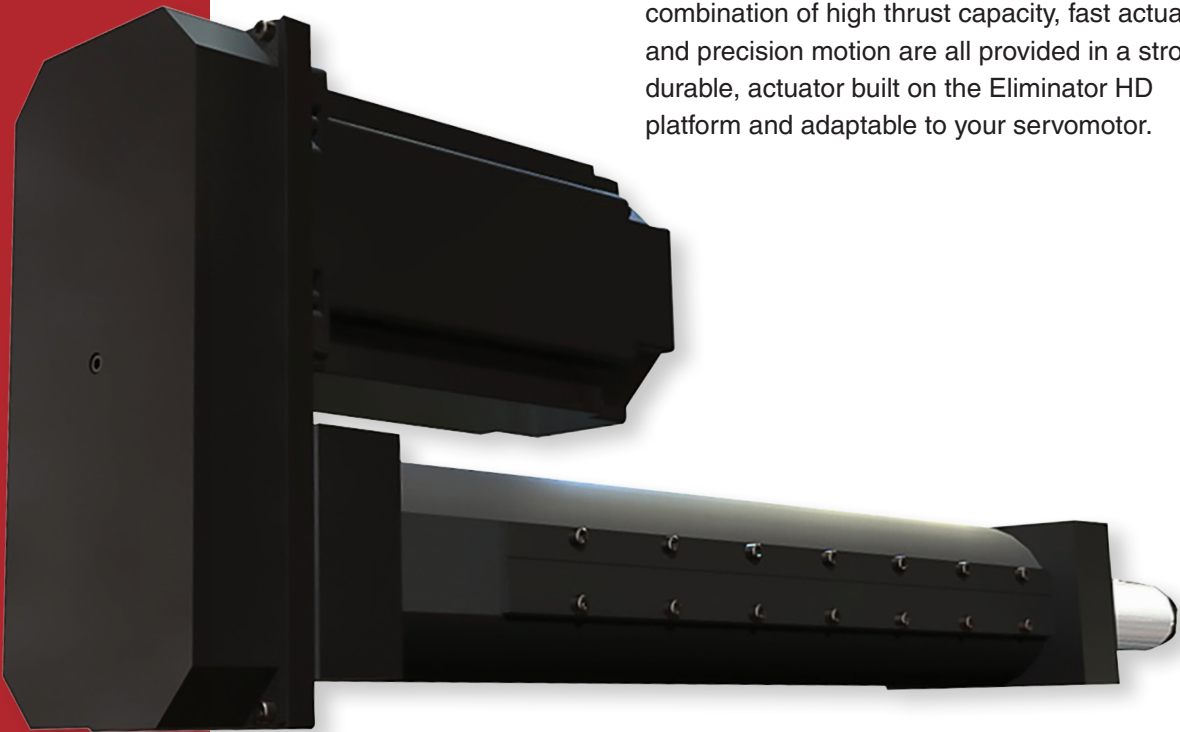

### *Ideal for a Variety of Applications Including:*

- Timber Processing
- Cut-Off Applications
- Packaging
- Hydraulic / Pneumatic Replacement
- And More

### **Key Features:**

- Rugged steel construction with durable anti-rotation feature
- Rated thrust up to 2,000 lbf
- Extreme speed capability up to 63 in/sec, stroke up to 48 inches
- Sealed chamber design with purge provisions to meet IP54
- 0.005 in/ft standard lead accuracy
- Standard backlash is 0.005 in maximum; optional zero backlash is also available

# SPECIFICATION CHART FOR THE ELIMINATOR SS ACTUATOR

Model Number	Thrust Load Rated	Linear Velocity Max. <sup>1</sup>	Travel Length Max. <sup>2</sup>	Frame Size	Lead	Ball Screw Diameter	Ball Screw Max. <sup>1</sup>	Torque @ Ball Screw Max.	Dynamic Capacity Per Million Revs	Dynamic Capacity Per Million Inches	Motor Gearhead Frame Supported Max. <sup>2</sup>
	lbr	in/s	in	in	in	in	RPM	in-lb	lbr	lbr	in
SS454	2,000	63	48	4.5	1.875	1.5	2,016	663	5,960	7,350	7

Model Number	Inertia 1:1 Zero Stroke <sup>3</sup>	Inertia 1:1 Per Inch of Stroke <sup>3</sup>	Inertia 2:1 Zero Stroke <sup>3</sup>	Inertia 2:1 Per Inch of Stroke <sup>3</sup>	Inertia Inline Zero Stroke <sup>3</sup>	Inertia Inline Per Inch of Stroke <sup>3</sup>	Unit Weight "U" Motor Mount <sup>4</sup>	Unit Weight "L" Motor Mount <sup>4</sup>	Weight Per Inch of Stroke <sup>4</sup>
	lb-in <sup>2</sup>	lb-in <sup>2</sup>	lb-in <sup>2</sup>	lb-in <sup>2</sup>	lb-in <sup>2</sup>	lb-in <sup>2</sup>	lb	lb	lb
SS454	18.43	0.1550	6.19	0.0388	3.24	0.1550	87	62	2.14

<sup>1</sup> Maximum velocity and maximum screw speed may not be achievable at maximum stroke.

<sup>2</sup> Larger Motor or Gearhead Frames and longer stroke lengths are available upon request.

<sup>3</sup> All inertia values are at the input shaft and are representative of typical pulleys, bushings, couplers, etc. Actual values may vary due to motor selection.

<sup>4</sup> Weight values are for reference only and vary depending on configuration.

"U" Parallel offset configuration

"L" Inline configuration

## DATA CURVES FOR THE ELIMINATOR SS ACTUATOR

**Dynamic Capacity: Life Vs. Load**

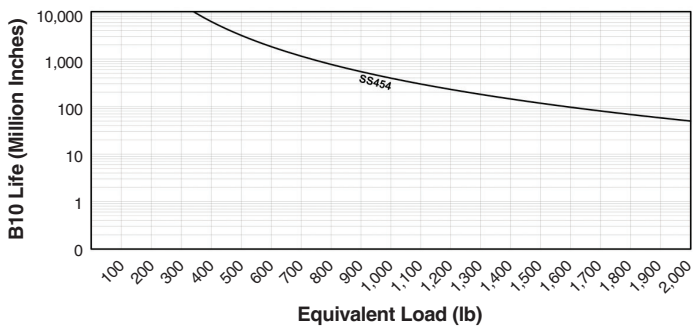

**Speed Vs. Stroke**

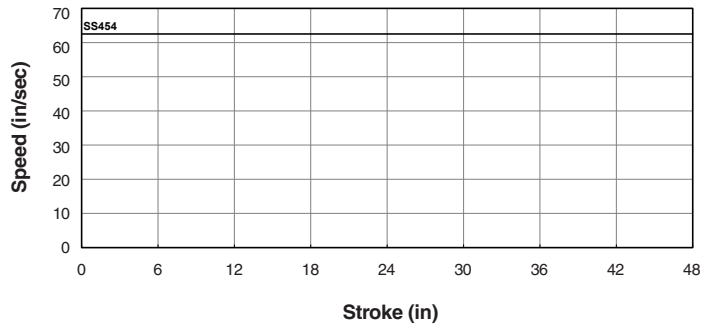

# DIMENSIONED DRAWINGS FOR THE ELIMINATOR SS ACTUATOR

Dimensions are in inches and are subject to change without notice.

## U-Parallel Offset Motor Configuration

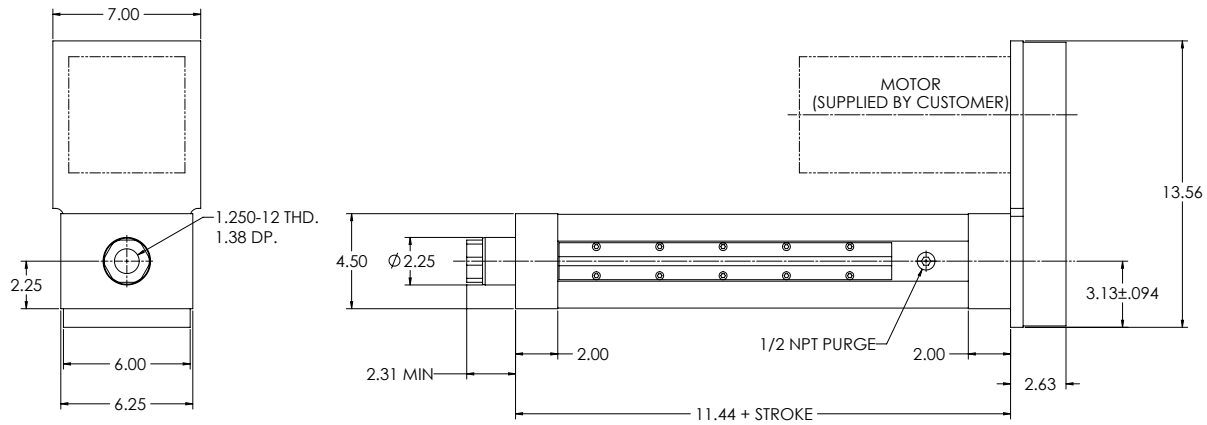

## L-Inline Motor Configuration

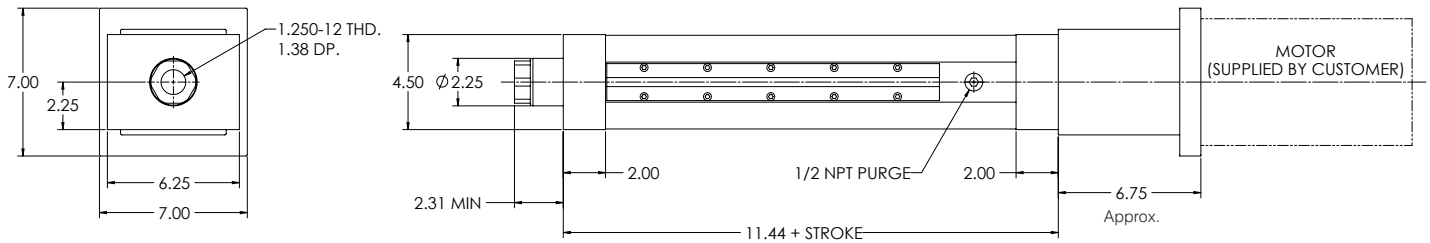

# DIMENSIONED DRAWINGS FOR THE ELIMINATOR SS ACTUATOR

Dimensions are in inches and are subject to change without notice.

## Bottom Mount Dimensions

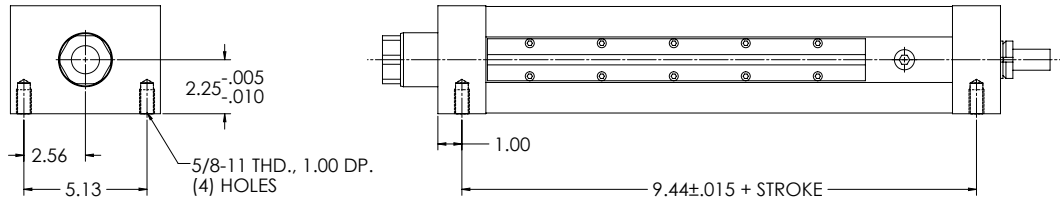

## Front Flange Dimensions

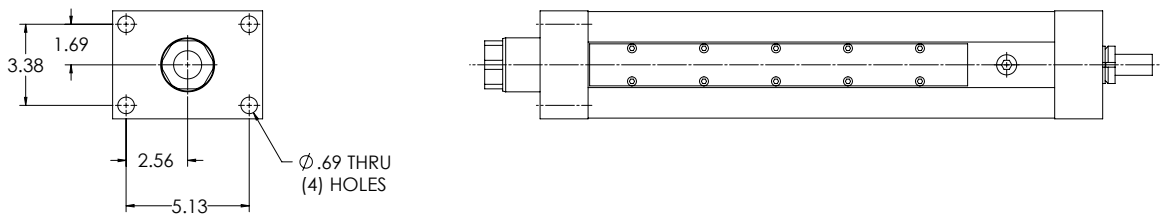

## Foot Mount Dimensions

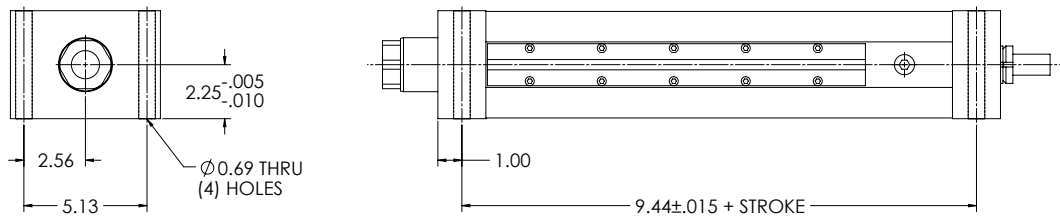

## Trunnion Mount Dimensions

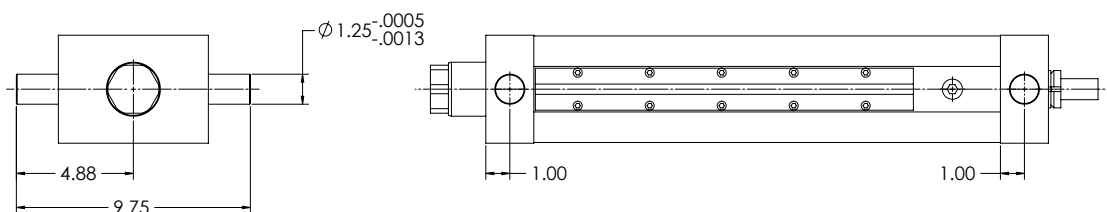

# DIMENSIONED DRAWINGS FOR THE ELIMINATOR SS ACTUATOR

Dimensions are in inches and are subject to change without notice.

## Rod End Options

### Self-Aligning Coupler

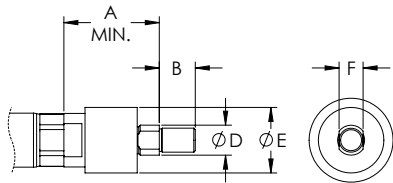

### Male Thread

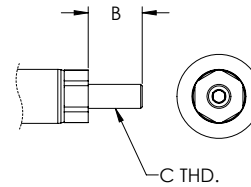

### Spherical Rod Eye

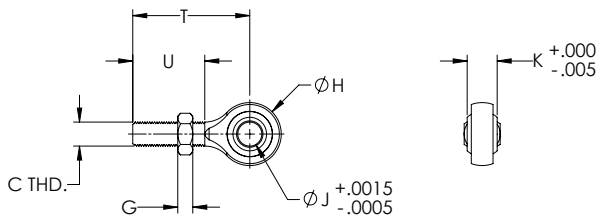

### Female Eye

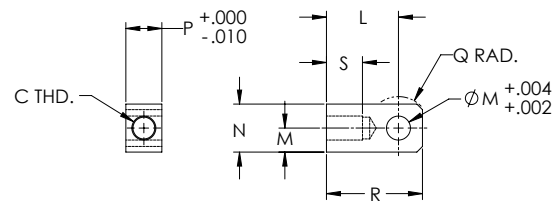

## SS Rod End Dimensions

Model	A	B	C	D	E	F	G	H	J	K	L	M	N	P	Q	R	S	T	U
SS454	2.94	1.63	1 1/4-12	1.45	3.13	1.25	0.72	2.75	1.00	1.38	3.44	1.38	2.75	2.00	1.38	4.81	2.00	4.13	2.13



# Eliminator SD™ Actuator

## EXTREME THRUST CAPABILITY IN ELIMINATOR HD PLATFORM

The Eliminator SD super duty linear actuator provides extreme thrust capacity for your high thrust industrial applications. Achieve the perfect high precision/high load capacity solution when you combine your servomotor with this heavy-duty steel actuator.

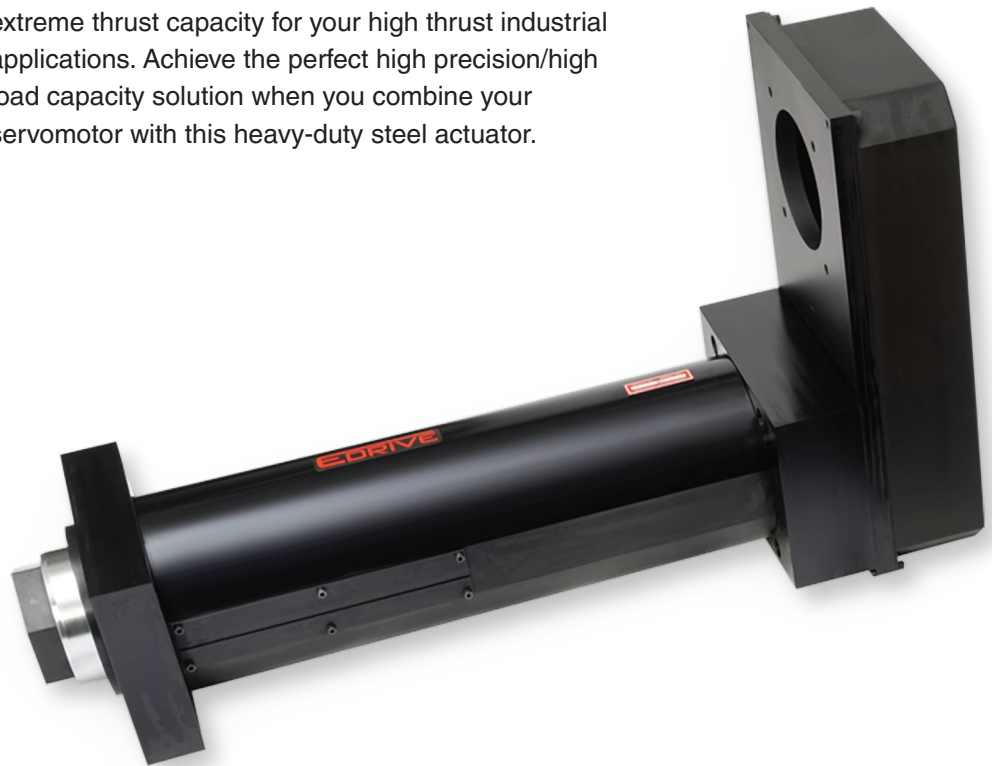

### *Ideal for a Variety of Applications Including:*

- Heavy Pressing / Punching / Staking
- Heavy Lifting
- Riveting / Fastening
- Cycle Testing
- Clamping / Stamping
- Hydraulic Replacement
- And More

### **Key Features:**

- Rugged steel construction with durable anti-rotation feature
- Extreme thrust capacity up to 100,000 lbf
- Velocity up to 12 in/sec, stroke up to 48 inches
- Combines with your servomotor to achieve the perfect high-precision/high-load capacity
- 0.002 in/ft standard lead accuracy
- Standard backlash is 0.003 in maximum

# SPECIFICATION CHART FOR THE ELIMINATOR SD ACTUATOR

Model Number	Thrust Load Rated	Linear Velocity Max. <sup>1</sup>	Travel Length Max. <sup>2</sup>	Frame Size	Lead	Ball Screw Diameter	Ball Screw Max. <sup>1</sup>	Torque @ Ball Screw Max.	Dynamic Capacity Per Million Revs	Dynamic Capacity Per Million Inches	Motor Gearhead Frame Supported Max. <sup>2</sup>
	lbr	in/s	in	in	in	in	RPM	in-lb	lbr	lbr	in
SD948	48,000	12.0	48	9.00	1.000	4.00	720	8,490	76,390	76,390	12
SD966	66,000	12.0	48	9.00	1.000	4.00	720	11,670	84,900	84,900	12
SD999	100,000	12.0	42	9.00	1.000	4.00	720	17,684	84,900	84,900	12

Model Number	Inertia 1:1 Zero Stroke <sup>3</sup>	Inertia 1:1 Per Inch of Stroke <sup>3</sup>	Inertia 2:1 Zero Stroke <sup>3</sup>	Inertia 2:1 Per Inch of Stroke <sup>3</sup>	Inertia Inline Zero Stroke <sup>3</sup>	Inertia Inline Per Inch of Stroke <sup>3</sup>	Unit Weight "U" Motor Mount <sup>4</sup>	Unit Weight "L" Motor Mount <sup>4</sup>	Weight Per Inch of Stroke <sup>4</sup>
	lb-in <sup>2</sup>	lb-in <sup>2</sup>	lb-in <sup>2</sup>	lb-in <sup>2</sup>	lb-in <sup>2</sup>	lb-in <sup>2</sup>	lb	lb	lb
SD948	1,099.84	4.7929	216.68	1.1982	211.02	4.7929	595	614	12.07
SD966	1,285.36	4.7929	279.53	1.1982	334.71	4.7929	609	628	12.07
SD999	1,564.22	4.9089	331.93	1.2272	116.89	4.9089	629	648	12.07

<sup>1</sup> Maximum velocity and maximum screw speed may not be achievable at maximum stroke.

<sup>2</sup> Larger Motor or Gearhead Frames and longer stroke lengths are available upon request.

<sup>3</sup> All inertia values are at the input shaft and are representative of typical pulleys, bushings, couplers, etc. Actual values may vary due to motor selection.

<sup>4</sup> Weight values are for reference only and vary depending on configuration.

"U" Parallel offset configuration

"L" Inline configuration

## DATA CURVES FOR THE ELIMINATOR SD ACTUATOR

### Dynamic Capacity: Life Vs. Load

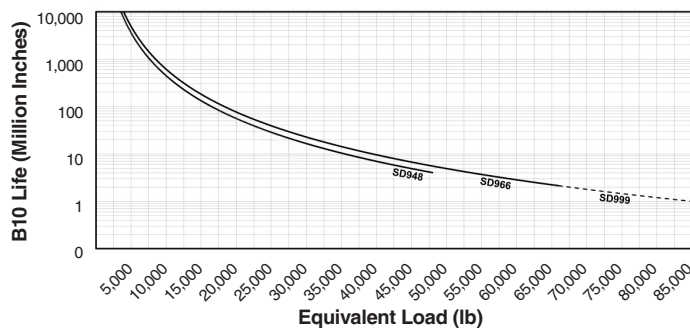

### Speed Vs. Stroke

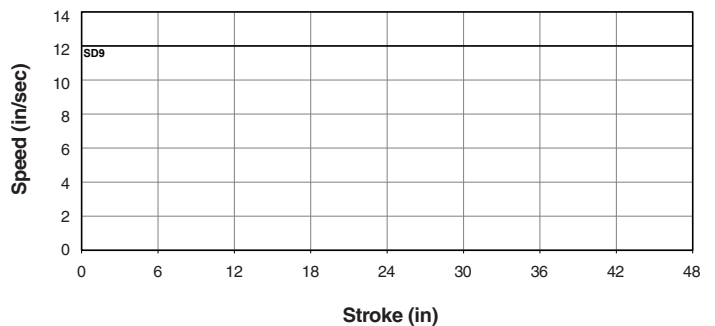

# DIMENSIONED DRAWINGS FOR THE ELIMINATOR SD ACTUATOR

Dimensions are in inches and are subject to change without notice.

## U-Parallel Offset Motor Configuration

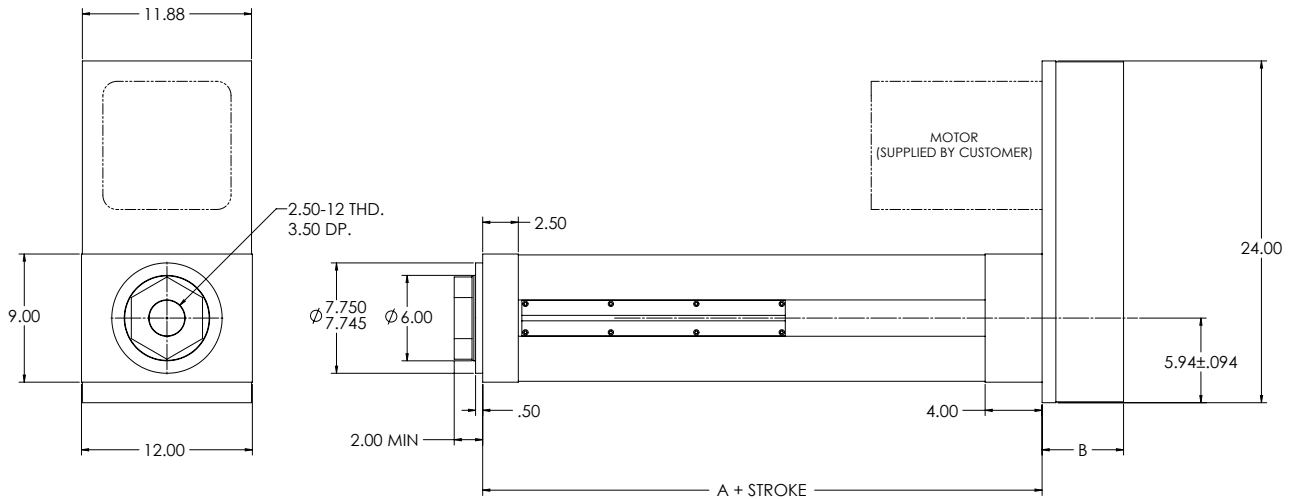

## L-Inline Motor Configuration

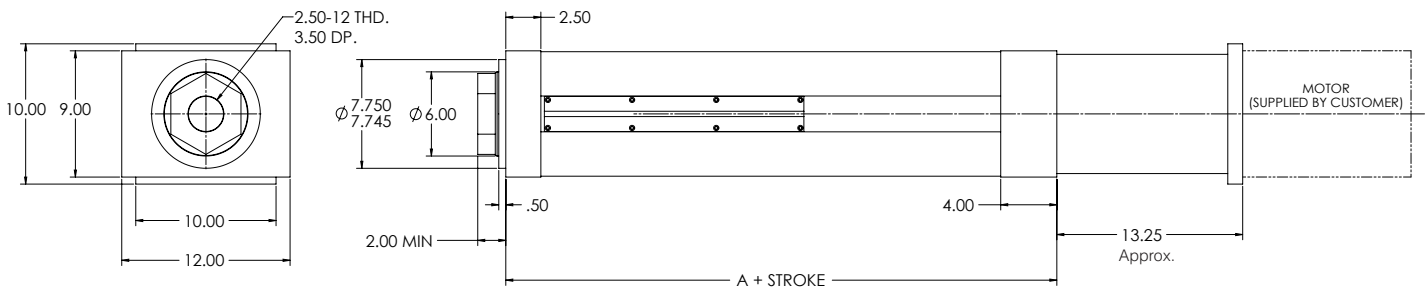

## SD U-Parallel Offset and L-Inline Motor Configuration

Model	A	B
SD948	27.28	5.72
SD966	27.28	5.72
SD999	29.88	6.22

# DIMENSIONED DRAWINGS FOR THE ELIMINATOR SD ACTUATOR

Dimensions are in inches and are subject to change without notice.

## Bottom Mount Dimensions

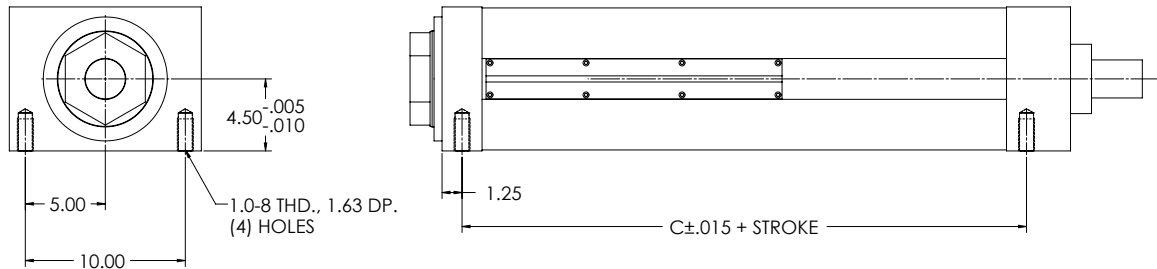

## Front Flange Dimensions

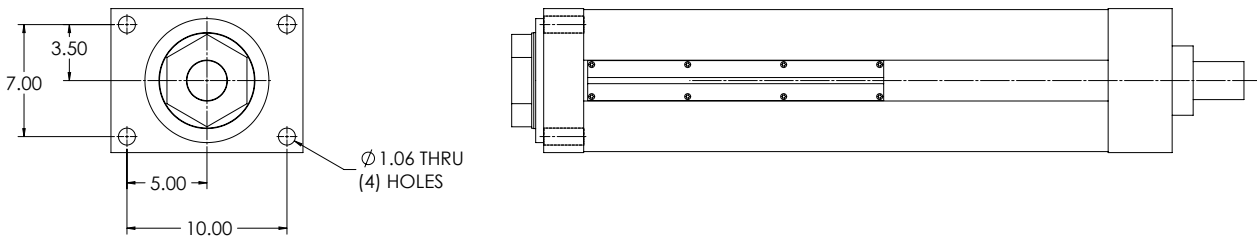

## Foot Mount Dimensions

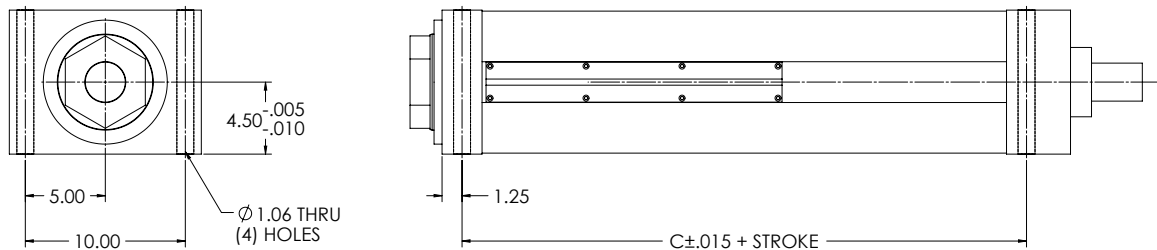

## Trunnion Mount Dimensions

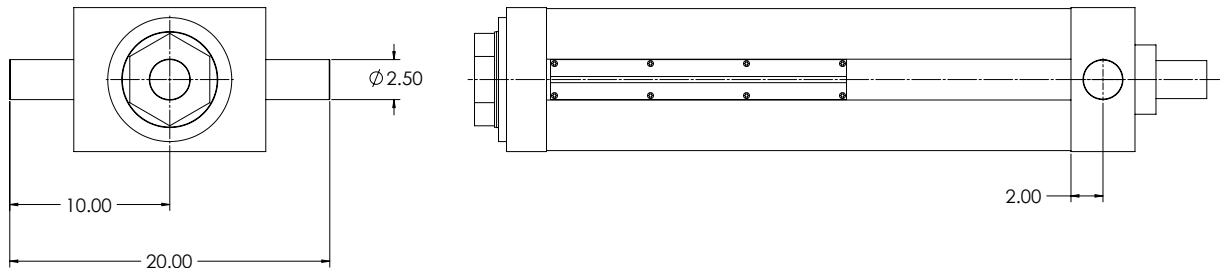

## SD Mounting Dimensions (Bottom Mount, Front Flange, Foot Mount, Trunnion Mount)

Model	C
SD948	23.28
SD966	23.28
SD999	25.88

# DIMENSIONED DRAWINGS FOR THE ELIMINATOR SD ACTUATOR

Dimensions are in inches and are subject to change without notice.

## Rod End Options

### Self-Aligning Coupler

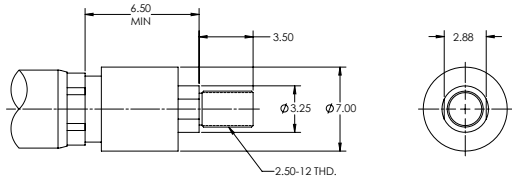

### Male Thread

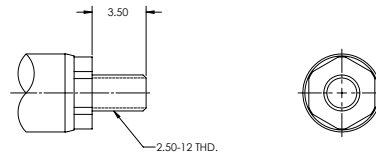

### Spherical Rod Eye

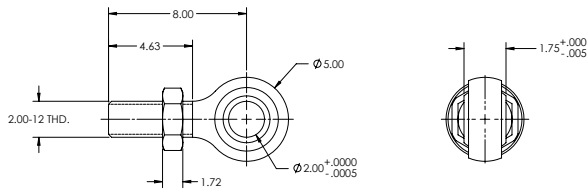

### Female Eye

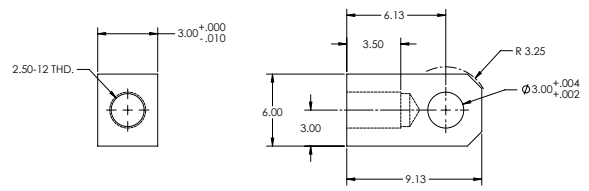

# ORDERING GUIDE FOR THE ELIMINATOR SD ACTUATOR

## Ordering Information

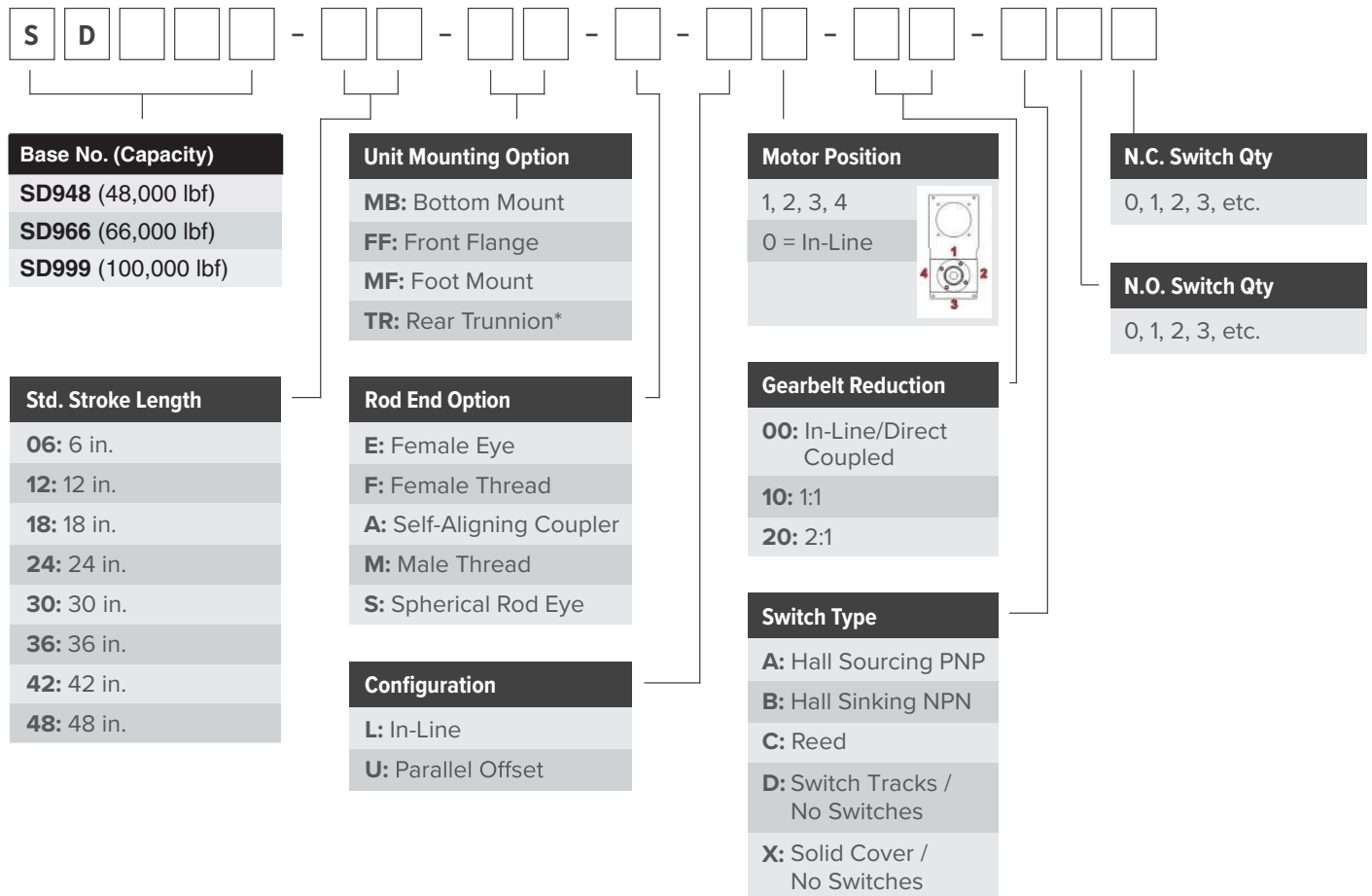

For custom stroke lengths, contact Joyce/Dayton.

\* Rear Trunnion not available for SD999

# Glossary

## Alignment

Alignment of the actuator, parallel to the line of motion, is critical. Also, the end effector connection must be designed to prevent any transfer of bending moments back to the actuator.

## B10 Life

B10 Life is expressed in total revolutions or inches of travel a properly maintained ball screw will operate under a rated load. 90% of all systems operated at this rated load will meet or exceed this rating. Although 10% may not reach a million inches, 50% could exceed 5 million inches.

Life under load (B10 life) is predictable; severe load applications can generally be compensated for by providing additional capacity.

## Contamination

Contamination of the ball screw system is the leading cause of premature failure. Providing a continuous, low pressure, air purge to the system is a good way to ensure clean operation.

## Force

Force, when calculating the required force, consider the force to accelerate the mass as well as the force to overcome the friction and the applied force. For sizing the system, consider the maximum force and duration. For evaluating life under varying loads, calculate the root mean cube equivalent load which weights the different load levels by the typical length traveled under that load.

## Impact

Impact is unacceptable to ball screws as well as anti-friction bearings. Severely shortened life and/or catastrophic failure are the results. Avoid impact or provide a mechanical system to buffer the ball screw assembly from shock loads.

## IP69K Rating

IP69K is the highest rating available on the internationally recognized scale for ingress protection (IP) against solids and liquids. EDrive SP, SPL and VP actuators have undergone rigorous testing to satisfy these IP69K standards making them ideal for food processing and medical applications requiring high-pressure and high-temperature washdown.



## Linear Velocity

Linear velocity is limited by (1): the maximum ball screw rpm without “whipping” of the ball screw shaft; (2) critical speeds for the ball nut assembly (beyond which the motion of the balls becomes erratic and performance life suffers).

## Lubrication

Good lubrication is essential. Do not mix lubricants. Refer to the Service Manual to determine the correct lubricant. Important: Oil systems are shipped dry. Lubrication lines must be connected, and the reservoir and all connections filled prior to operating the actuator. Grease systems come pre-lubricated but should be periodically inspected (if applicable) to ensure adequate lubricant to critical areas of the ball screw.

## Maximum Acceleration

Maximum acceleration of ball screw assembly is approximately 32 ft/s<sup>2</sup>, above this level, unit life becomes shorter and less predictable.

## Side Loads

Side loads are undesirable. Almost any force not coaxial to the actuator compromises potential life.

## Stiffness

System stiffness is an essential attribute of high accuracy positioning systems. Specifying 0.0005 inch positioning accuracy and repeatability without considering spring rate may result in disappointing performance. For precision light duty applications a spring constant of 1 x 10<sup>6</sup> lbs/in is acceptable and a range of 3 x 10<sup>6</sup> to 6 x 10<sup>6</sup> lbs/in may be necessary for higher load applications.

# Technical FAQ

## How do I install/tension the gearbelt and how tight should it be?

Belt tensioning procedures vary from product to product. Please refer to the Service Information section of the website for more specific information.

## How do I lubricate my actuator?

Lubrication methods and the choice of lubricant may vary from product to product. Please refer to the Service Information section of our website for this information.

## What is the rated operating temperature range?

The normal rated operating temperature range for most EDrive actuators is -20°F to 175°F. For help specifying actuators which require operation outside of this temperature range contact [sales@joycedayton.com](mailto:sales@joycedayton.com) or speak with our customer service team at (937) 294-6261.





## What does B10 Life mean?

B10 life is expressed in total revolutions or inches of travel a properly maintained ball screw will operate under a rated load. 90% of all systems operated at this rated load will meet or exceed this rating. Although 10% may not reach a million inches, 50% could exceed 5 million inches. Life under load (B10 life) is predictable; severe load applications can generally be compensated for by providing additional capacity.

## Does EDrive offer an integrated load cell option for actuators?

Yes. EDrive offers an Integrated Load Cell option for many of our products. This option combines force measurement with heavy-duty and precise linear motion. It provides a clean, simple, rugged, and economical capability to directly and continuously monitor axial force while simultaneously applying that force. Examples of products with the Load Cell option include HDL and SPL actuators.

## IP69K Rating - What does it mean and why is it preferred?

IP69K indicates the highest rating available on the internationally recognized scale for classifying ingress protection against dust and high-temperature, high-pressure liquids. Products with IP69K protection are ideal for use in industries such as Food Processing and Medical Equipment applications where equipment must routinely withstand rigorous washdown procedures.

# How to Select an Actuator

## Selection Guidelines

### 1. Define the Motion Profile

Gather all the necessary application details including application stroke length, loads and forces, total cycle time, and duty cycle to define the required velocities in forces in each of the motion profile segments. The EDrive application worksheet can be used to gather this necessary information.

### 2. Calculate Equivalent Load

Using the segment stroke lengths and forces, calculate the equivalent load of the application using the formula found in the “How to Calculate Equivalent Load” section.

### 3. Select Actuator Size

Select an actuator size capable of the required stroke, peak linear velocity, and peak force from the application requirements. Verify that the applications peak linear velocity as well as peak force do not exceed the max values of the size actuator selected. Standard stroke lengths are available in increments of 6 inches, but in-between lengths are available upon request.

### 4. Calculate B10 Life

Using the calculated equivalent load, determine the estimated B10 life of the selected actuator size from the Life Vs. Load charts. It is possible the actuator selection may need to be adjusted to achieve a desirable B10 life.

### 5. Environmental Considerations

Determine the environmental requirements of the application. If ingress protection against dust and/or water is needed, select a series actuator with a higher IP rating. If the ambient temperature of the application is not within the operating range of the selected actuator, contact Joyce/Dayton.

### 6. Select a Motor Configuration

Select a parallel offset or inline motor mounting configuration. If parallel offset, select between a standard 1:1 or 2:1 reduction ratio.

### 7. Establish Total Torque Requirements

Total system inertia values can be found in the product spec charts. Calculate the peak and the RMS torque and speeds required from the motor for the motion profile.

### 8. Select a Motor

Use the calculated torque and speed values to select a motor and reduction ratio (if applicable) to select an appropriate motor for the application. The motor part number is to be included at the end of the EDrive part number string.

### 9. Select Actuator Mounting and Rod End Options

Actuator mounting and rod end options can be found in the dimensioned drawings section for each product line. When selecting a trunnion mounted actuator, select either front trunnion or rear trunnion as the actuator will not come equipped with both. For custom mounting options contact Joyce/Dayton.

### 10. Select Optional Position Sensors

The 6 standard sensor options to choose from include reed, PNP, and NPN switch types all offered as normally open or normally closed with 6 foot flying leads.

### 11. Configure Part Number

Ordering guides are found with each product. Based upon all of the selections made in the previous steps, configure the complete actuator part number to send to EDrive for quoting.

# Calculations

## Equivalent Load

The equivalent load is the average force over the working stroke, weighted proportionately to the distance traveled. For constant force loads, the equivalent load is the same as the typical or average load. Where forces vary due to gravity, angle of actuator, acceleration and deceleration, friction, and changing dynamic loads at different positions, it is best to determine the equivalent load in order to most accurately predict the B10 life of the actuator.

$$F_e = \sqrt[3]{\frac{L_1(F_1)^3 + L_2(F_2)^3 + L_3(F_3)^3 + L_4(F_4)^3 + \dots + L_n(F_n)^3}{L}}$$

$F_e$  = Equivalent Load (lbf)

$F_n$  = Calculated force for segment "n" (lbf)

$L_n$  = Travel distance for segment "n" (in)

$L$  = The total travel of all segments (in)

## Drive Torque

Edrive considers its ball screw actuators to be 90% efficient. When a 2:1 belt ratio is used, the required input torque is halved. Due to variations in actuator efficiency, it is recommended when sizing a motor to have some excess torque.

$$T_d = \frac{F \times L}{2 \pi \epsilon}$$

$T_d$  = Drive Torque at Ball Screw (in-lb)

$F$  = Output Force (lbf)

$L$  = Ball Screw Lead (in)

$\epsilon$  = Efficiency

## Holding Torque

Due to the high efficiency of the ball screw, torque is required to hold a stationary load. Otherwise the actuator will freely backdrive. If holding position without power to the motor is required, a motor brake is recommended. When a 2:1 belt ratio is used, the required holding torque is halved. Due to variations in actuator efficiency, it is recommended when sizing a motor to have some excess torque.

$$T_h = \frac{F \times L \times \epsilon}{2 \pi}$$

$T_h$  = Holding Torque at Ball Screw (in-lb)

$F$  = Output Force (lbf)

$L$  = Ball Screw Lead (in)

$\epsilon$  = Efficiency

## Drive RPM

When a 2:1 belt ratio is used, the required input RPM is doubled.

$$RPM = \frac{V \times 60}{L}$$

RPM = Rotations Per Minute

$V$  = Linear Velocity of Actuator (in/sec)

$L$  = Screw Lead (in)

# Wiring Diagrams

## FB6402 HD Load Cell Wiring Diagram

Rated Output, Typical	2 mV/V
Combined error	0.25% F.S.
Non-Repeatability	0.05% F.S.
Zero Balance	1% R.O.
Temperature Range Compensated	50°F to 120°F
Temperature Effect, Output	0.0008% of load / °F
Temperature Effects, Zero Balance	0.02% / R.O. / °F
Bridge Impedance, Typical	700 ohms
Excitation Voltage, Typical	10 VDC or VAC rms
Excitation Voltage, Maximum	15 VDC or VAC rms
Insulation resistance	>5,000 megohms at 50 VDC
Overload, Safe	150% over Capacity
Overload, Ultimate	200% over Capacity
Deflection at Rated Capacity, Approx.	0.0015 inch
Construction	Tool Steel

Cable Pin Configuration	Receptacle Type		Load Cell Cable	
	Color	Function	Color	Function
1	Green	+ Excitation	Gray	+ Excitation
2	Black	- Excitation	Gray stripe	- Excitation
3	White	+ Signal	Orange	+ Output
4	Red	- Signal	Orange stripe	- Output

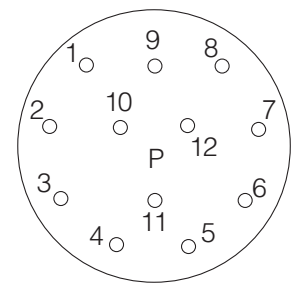

View of Receptacle

# FB6422 Hall Effect Reed Limit Switches

## Actuator Limit Switch

Supplied with Hall Effect or Reed type switches which are for “home” sensing and over-travel protection only. They should not be used to position the actuator.

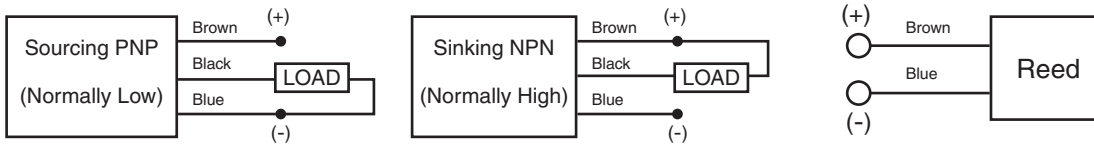

	Configuration	State	Voltage (VDC Typ.)	Current (mA Max.)	Type	Part Number
A	Hall Effect, Sourcing	N.O.	5-24	500	PNP	MLE-K06
A	Hall Effect, Sourcing	N.C.	5-24	500	PNP	MLE-Q06
B	Hall Effect, Sinking	N.O.	5-24	500	NPN	MLE-G06
B	Hall Effect, Sinking	N.C.	5-24	500	NPN	MLE-J06

	Configuration	State	Contact Rating (VA)	Switching Voltage (Max.) V(AC/DC)	Switching Current (Max.) (mA)	Carry Current (Max.)	Part Number
C	Reed	N.O.	10	100	500	1 A	MLE-D06
C	Reed	N.C.	3	30	200	500 mA	MLE-T06

PVC Jacket	PVC Jacket, 24 AWG, 105 strand, (+) Brown, (-) Blue, (load) Black
Length	6 feet
Switch Response	0.01 mS
Operating Temperature	-10 to 60 degrees C
Shock Resistance	50 g. Hall, 10 g. Reed
Vibration Resistance	30 g.
Magnetic Field Required	40 gauss minimum, no upper limit

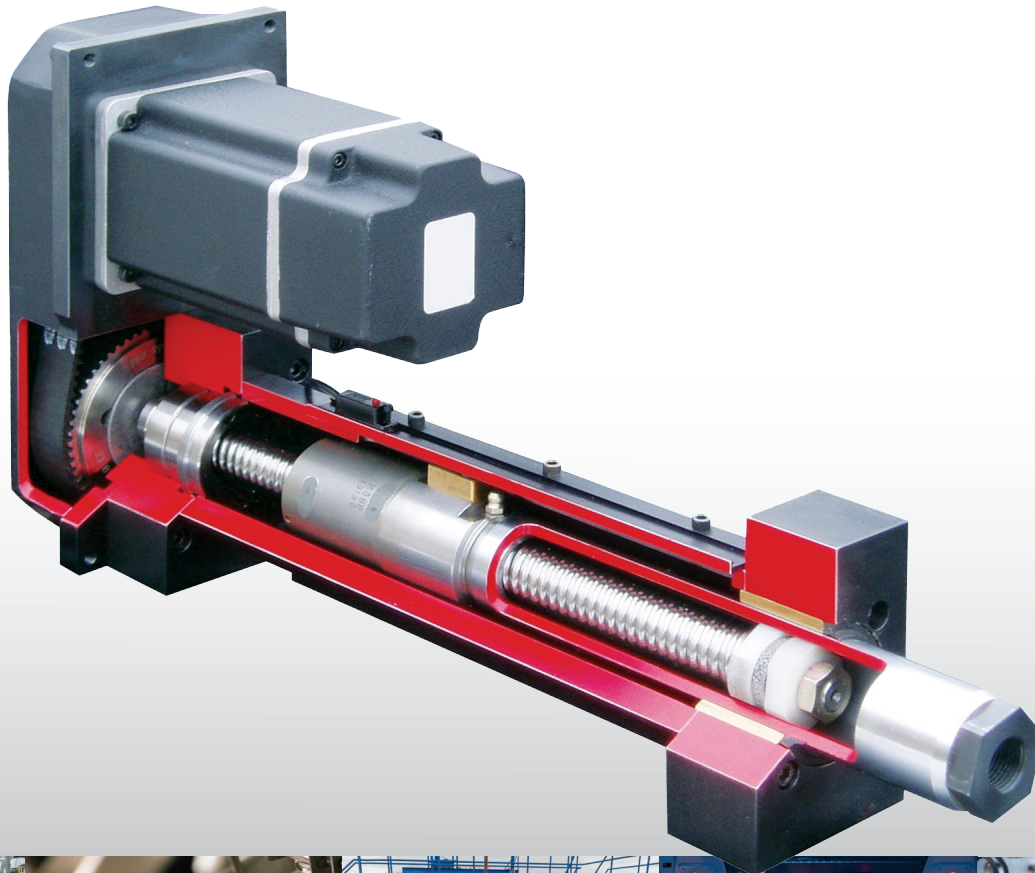

For standard, or fully customized, electric actuators, look to EDrive Actuators. As part of the Joyce/Dayton family, we deliver linear motion solutions you can trust. Contact our experienced staff today!

**JOYCE**<sup>®</sup>

**EDRIVE**<sup>®</sup>  
ACTUATORS  
A JOYCE/DAYTON BRAND

Phone: **+1 (937) 294-6261**  
**sales@joycedayton.com**

**joycedayton.com/edrive**